



# AS2070: Aerospace Structural Mechanics

## Module 2: Composite Material Mechanics

**Instructor: Nidish Narayanaa Balaji**

**Dept. of Aerospace Engg., IIT Madras, Chennai**

April 5, 2025

# Table of Contents

(Also see Daniel and Ishai 2006)

- 1 Introduction
  - What are Composites?
  - Modeling Composite Material
  - Constitutive Modeling for Composites
  - Classical Laminate Theory
- 2 Composite Materials
  - Types of Composite Materials
- 3 Micro-Mechanics Descriptions
  - The Rule of Mixtures
  - Numerical Example
- 4 Macro-Mechanics Descriptions
  - Material Symmetry and Anisotropy
- 5 Analysis of Planar Laminates
  - Generally Orthotropic Laminates
  - Numerical Examples
- 6 Classical Laminate Theory
  - The Laminate Orientation Code
  - Laminated Beams
  - Numerical Example

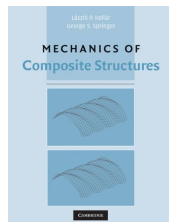

Chapters 1-3, 11  
in Kollár and  
Springer (2003).

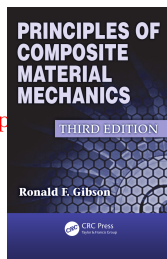

Chapters 1-3  
in Gibson  
(2012).

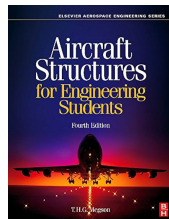

Chapter 25  
in Megson  
(2013)

# 1.1. What are Composites?

## Introduction

- Structural material consisting of multiple non-soluble macro-constituents.
- Main motivation: material properties tailored to applications.
- Both stiffness and strength comes from the fibers/particles, and the matrix holds everything together.

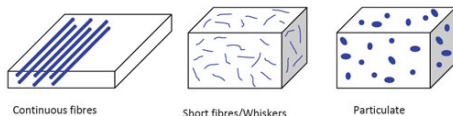

*Types of composite materials (Figure from NPTEL Online-IIT KANPUR (2025))*

## Examples

- Reinforced concrete
- Wood (lignin matrix reinforced by cellulose fibers)
- Carbon-Fiber Reinforced Plastics (CFRP)

# 1.1. What are Composites?

## Introduction

- Structural material consisting of multiple non-soluble macro-constituents.
- Main motivation: material properties tailored to applications.
- Both stiffness and strength comes from the fibers/particles, and the matrix holds everything together.

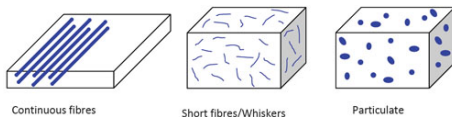

*Types of composite materials (Figure from NPTEL Online-IIT KANPUR (2025))*

## Examples

- Reinforced concrete
- Wood (lignin matrix reinforced by cellulose fibers)
- Carbon-Fiber Reinforced Plastics (CFRP)

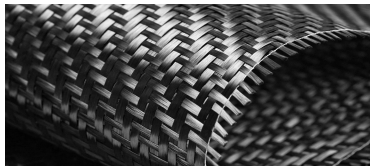

# 1.1. What are Composites?

## Introduction

- Structural material consisting of multiple non-soluble macro-constituents.

### CFRP Helicopter Blades

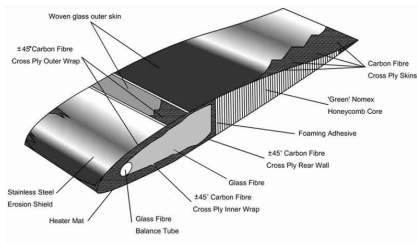

(Figures from *Carbon Fiber Top Helicopter Blades 2025*)

Ex

- Reinforced concrete
- Wood (lignin matrix reinforced by cellulose fibers)
- Carbon-Fiber Reinforced Plastics (CFRP)
  - ~2x stiffness, ~3x strength, ~70% weight of AA.
  - High fatigue resistance. But quite brittle.
  - Main- and tail-planes, fuselages, etc. Helicopter blades.

# 1.1. What are Composites?

## Introduction

- Structural material consisting of multiple non-soluble macro-constituents.

### Laminated Composites

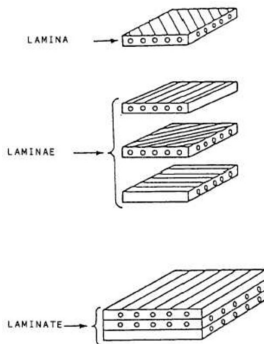

(Figure from Kalkan 2017)

Ex

- Reinforced concrete
- Wood (lignin and cellulose fibers)
- Carbon-Fiber Reinforced Plastics (CFRP)

- Main- and tail-planes, fuselages, etc. Helicopter blades.



Strength, ~ 70%

But quite brittle.

# 1.2. Modeling Composite Material

## Introduction

Two main approaches:

### Micro-Mechanics

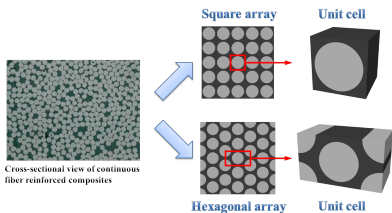

(Figure from "Micro-Mechanics of Failure" 2024)

### Macro-Mechanics

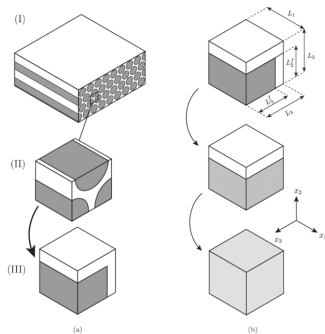

Homogenization of micro-structure (Figure from Skovsgaard and Heide-Jørgensen 2021)

# 1.2. Modeling Composite Material

## Introduction

Two main approaches:

### Micro-Mechanics

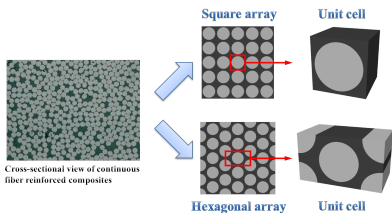

Cross-sectional view of continuous fiber reinforced composites

(Figure from "Micro-Mechanics of Failure" 2024)

### Macro-Mechanics ✓

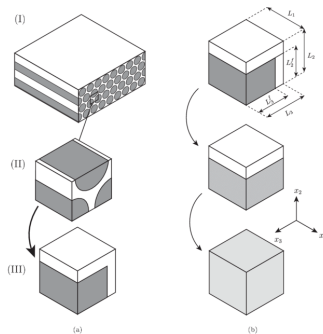

Homogenization of micro-structure (Figure from Skovsgaard and Heide-Jørgensen 2021)



# 1.3. Constitutive Modeling for Composites

## Introduction

### Axial Elongation

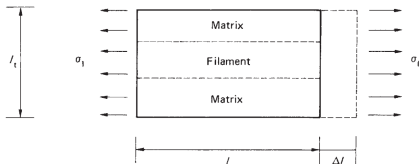

- Strain is fixed, but stress experienced by media differ.

$$\sigma_l = E_l \varepsilon_l$$

- Stress-strain relationship simplifies as,

$$\sigma_m = E_m \varepsilon_l, \quad \sigma_f = E_f \varepsilon_l$$

$$\sigma_l A = \sigma_m A_m + \sigma_f A_f$$

$$\Rightarrow E_l = \frac{A_f}{A} E_f + \frac{A_m}{A} E_m$$

# 1.3. Constitutive Modeling for Composites

## Introduction

### Axial Elongation

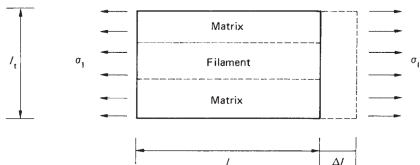

- Strain is fixed, but stress experienced by media differ.

$$\sigma_l = E_l \varepsilon_l$$

- Stress-strain relationship simplifies as,

$$\sigma_m = E_m \varepsilon_l, \quad \sigma_f = E_f \varepsilon_l$$

$$\sigma_l A = \sigma_m A_m + \sigma_f A_f$$

$$\Rightarrow E_l = \frac{A_f}{A} E_f + \frac{A_m}{A} E_m$$

### Transverse Elongation

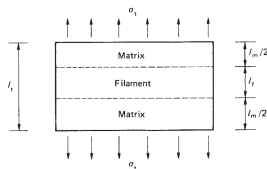

- Stress is fixed, strains differ:

$$\begin{aligned} \varepsilon_t l_t &= \varepsilon_m l_m + \varepsilon_f l_f \\ \Rightarrow \frac{\sigma_t}{E_t} l_t &= \frac{\sigma_t}{E_m} l_m + \frac{\sigma_t}{E_f} l_f \\ \Rightarrow \frac{1}{E_t} &= \frac{1}{E_m} \frac{l_m}{l_t} + \frac{1}{E_f} \frac{l_f}{l_t} \end{aligned}$$

# 1.3. Constitutive Modeling for Composites

## Introduction: Poisson Effects

### Axial-Transverse Coupling

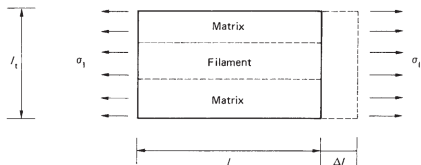

- Transverse displacement written as

$$\Delta_t = \nu_m \varepsilon_l l_m + \nu_f \varepsilon_l l_f := \nu_{lt} \varepsilon_l l_t$$

$$\Rightarrow \nu_{lt} = \frac{l_m}{l_t} \varepsilon_l + \frac{l_f}{l_t} \varepsilon_f$$

(Figures from Megson 2013)

# 1.3. Constitutive Modeling for Composites

Introduction: Poisson Effects

## Axial-Transverse Coupling

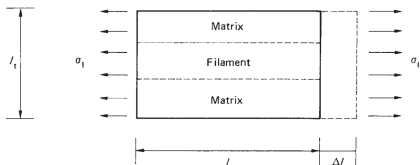

- Transverse displacement written as

$$\Delta_t = \nu_m \varepsilon_l l_m + \nu_f \varepsilon_l l_f := \nu_{lt} \varepsilon_l l_t$$

$$\Rightarrow \nu_{lt} = \frac{l_m}{l_t} \varepsilon_l + \frac{l_f}{l_t} \varepsilon_f$$

## Transverse-Axial Coupling

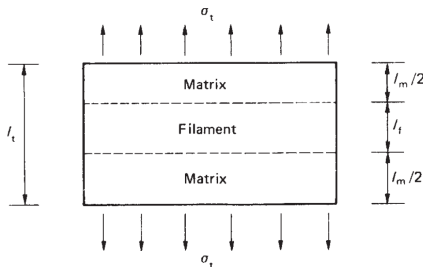

- Axial displacement written as

$$\nu_m \frac{\sigma_t}{E_m} = \nu_f \frac{\sigma_t}{E_f} := \nu_{tl} \frac{\sigma_t}{E_t}$$

$$\Rightarrow \nu_{tl} = \frac{E_t}{E_l} \nu_{lt}$$

(Figures from Megson 2013)

# 1.3. Constitutive Modeling for Composites

## Introduction: Poisson Effects

### Axial-Transverse Coupling

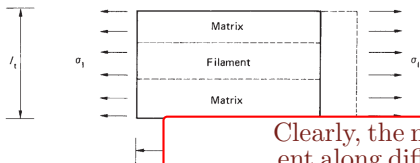

Clearly, the moduli are different along different directions!

- Transverse displacement written as

$$\Delta_t = \nu_m \varepsilon_l l_m + \nu_f \varepsilon_l l_f := \nu_{lt} \varepsilon_l l_t$$

$$\Rightarrow \nu_{lt} = \frac{l_m}{l_t} \varepsilon_l + \frac{l_f}{l_t} \varepsilon_f$$

### Transverse-Axial Coupling

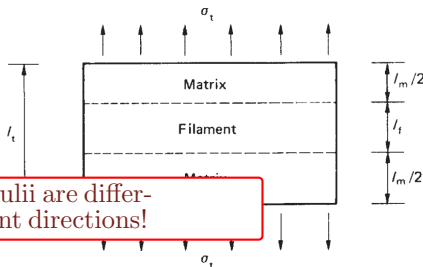

- Axial displacement written as

$$\nu_m \frac{\sigma_t}{E_m} = \nu_f \frac{\sigma_t}{E_f} := \nu_{tl} \frac{\sigma_t}{E_t}$$

$$\Rightarrow \nu_{tl} = \frac{E_t}{E_l} \nu_{lt}$$

(Figures from Megson 2013)

# 1.3. Constitutive Modeling for Composites

Introduction: Anisotropy

## General Anisotropy

$$\begin{bmatrix} \sigma_{xx} \\ \sigma_{yy} \\ \sigma_{zz} \\ \sigma_{xy} \\ \sigma_{xz} \\ \sigma_{yz} \end{bmatrix} = \begin{bmatrix} C_{11} & C_{12} & C_{13} & C_{14} & C_{15} & C_{16} \\ C_{12} & C_{22} & C_{23} & C_{24} & C_{25} & C_{26} \\ C_{13} & C_{23} & C_{33} & C_{34} & C_{35} & C_{36} \\ C_{14} & C_{24} & C_{34} & C_{44} & C_{45} & C_{46} \\ C_{15} & C_{25} & C_{35} & C_{45} & C_{55} & C_{56} \\ C_{16} & C_{26} & C_{36} & C_{46} & C_{56} & C_{66} \end{bmatrix} \begin{bmatrix} \varepsilon_{xx} \\ \varepsilon_{yy} \\ \varepsilon_{zz} \\ \gamma_{xy} \\ \gamma_{xz} \\ \gamma_{yz} \end{bmatrix}$$

# 1.3. Constitutive Modeling for Composites

Introduction: Anisotropy

## General Anisotropy

$$\begin{bmatrix} \sigma_{xx} \\ \sigma_{yy} \\ \sigma_{zz} \\ \sigma_{xy} \\ \sigma_{xz} \\ \sigma_{yz} \end{bmatrix} = \begin{bmatrix} C_{11} & C_{12} & C_{13} & C_{14} & C_{15} & C_{16} \\ C_{12} & C_{22} & C_{23} & C_{24} & C_{25} & C_{26} \\ C_{13} & C_{23} & C_{33} & C_{34} & C_{35} & C_{36} \\ C_{14} & C_{24} & C_{34} & C_{44} & C_{45} & C_{46} \\ C_{15} & C_{25} & C_{35} & C_{45} & C_{55} & C_{56} \\ C_{16} & C_{26} & C_{36} & C_{46} & C_{56} & C_{66} \end{bmatrix} \begin{bmatrix} \epsilon_{xx} \\ \epsilon_{yy} \\ \epsilon_{zz} \\ \gamma_{xy} \\ \gamma_{xz} \\ \gamma_{yz} \end{bmatrix}$$

## Monoclinic: Single Plane of Symmetry

$$\begin{bmatrix} \sigma_{xx} \\ \sigma_{yy} \\ \sigma_{zz} \\ \sigma_{xy} \\ \sigma_{xz} \\ \sigma_{yz} \end{bmatrix} = \begin{bmatrix} C_{11} & C_{12} & C_{13} & C_{14} & 0 & 0 \\ C_{12} & C_{22} & C_{23} & C_{24} & 0 & 0 \\ C_{13} & C_{23} & C_{33} & C_{34} & 0 & 0 \\ C_{14} & C_{24} & C_{34} & C_{44} & 0 & 0 \\ 0 & 0 & 0 & 0 & C_{55} & C_{56} \\ 0 & 0 & 0 & 0 & C_{56} & C_{66} \end{bmatrix} \begin{bmatrix} \epsilon_{xx} \\ \epsilon_{yy} \\ \epsilon_{zz} \\ \gamma_{xy} \\ \gamma_{xz} \\ \gamma_{yz} \end{bmatrix}$$

# 1.3. Constitutive Modeling for Composites

Introduction: Anisotropy

## Triclinic: Three Planes of Symmetry

$$\begin{bmatrix} \sigma_{xx} \\ \sigma_{yy} \\ \sigma_{zz} \\ \sigma_{xy} \\ \sigma_{xz} \\ \sigma_{yz} \end{bmatrix} = \begin{bmatrix} C_{11} & C_{12} & C_{13} & 0 & 0 & 0 \\ C_{12} & C_{22} & C_{23} & 0 & 0 & 0 \\ C_{13} & C_{23} & C_{33} & 0 & 0 & 0 \\ 0 & 0 & 0 & C_{44} & 0 & 0 \\ 0 & 0 & 0 & 0 & C_{55} & 0 \\ 0 & 0 & 0 & 0 & 0 & C_{66} \end{bmatrix} \begin{bmatrix} \epsilon_{xx} \\ \epsilon_{yy} \\ \epsilon_{zz} \\ \gamma_{xy} \\ \gamma_{xz} \\ \gamma_{yz} \end{bmatrix}$$

## Transversely Isotropic

$$\begin{bmatrix} \sigma_{xx} \\ \sigma_{yy} \\ \sigma_{zz} \\ \sigma_{xy} \\ \sigma_{xz} \\ \sigma_{yz} \end{bmatrix} = \begin{bmatrix} C_{11} & C_{12} & C_{13} & 0 & 0 & 0 \\ C_{12} & C_{22} & C_{13} & 0 & 0 & 0 \\ C_{13} & C_{13} & C_{33} & 0 & 0 & 0 \\ 0 & 0 & 0 & C_{44} & 0 & 0 \\ 0 & 0 & 0 & 0 & C_{44} & 0 \\ 0 & 0 & 0 & 0 & 0 & \frac{C_{11}-C_{12}}{2} \end{bmatrix} \begin{bmatrix} \epsilon_{xx} \\ \epsilon_{yy} \\ \epsilon_{zz} \\ \gamma_{xy} \\ \gamma_{xz} \\ \gamma_{yz} \end{bmatrix}$$



# 1.4. Classical Laminate Theory

## Introduction

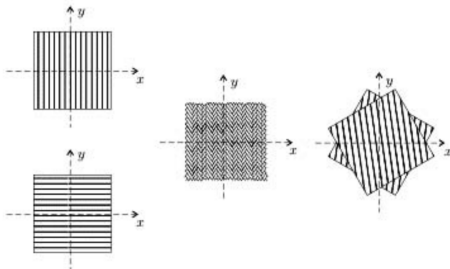
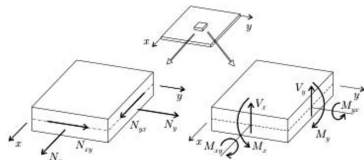
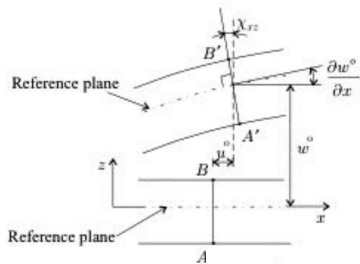

Figures from Kollár and Springer 2003

## 2. Composite Materials

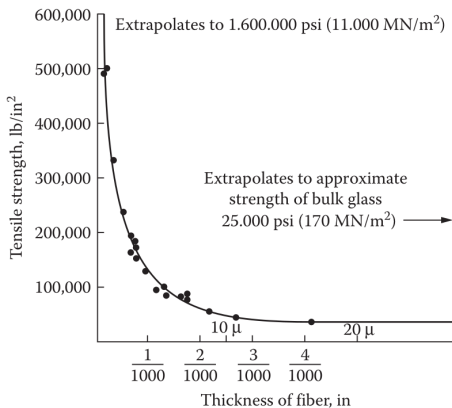

*Griffith's experiments with glass fibres (1920)*

(Figure from Gibson 2012)

## 2. Composite Materials

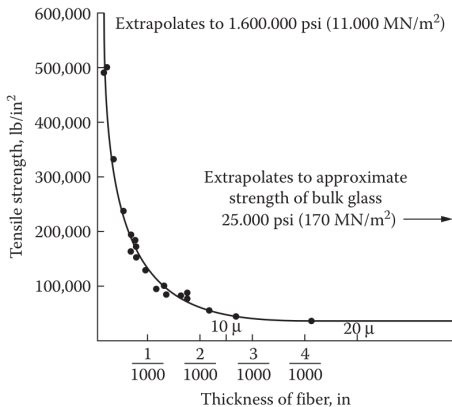

*Griffith's experiments with glass fibres (1920)*

(Figure from Gibson 2012)

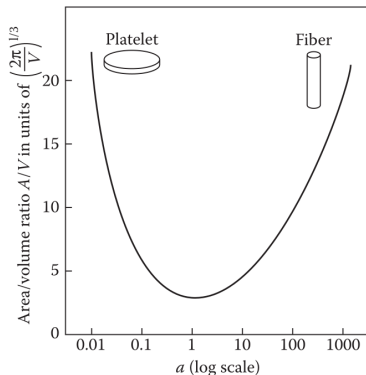

(Figure from Gibson 2012)

## 2.1. Types of Composite Materials

### Composite Materials

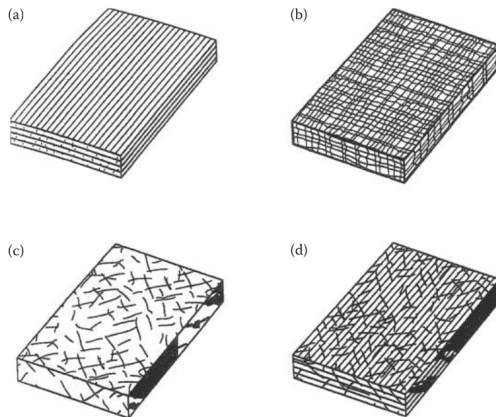

**FIGURE 1.4**

Types of fiber-reinforced composites. (a) Continuous fiber composite, (b) woven composite, (c) chopped fiber composite, and (d) hybrid composite.

*(Figure from Gibson 2012)*

## 3.1. The Rule of Mixtures

### Micro-Mechanics Descriptions

The *rule of mixtures* is introduced as a very simple framework for developing “overall”/representative mechanical properties.

### Basic Definitions

Subscripts  $(\cdot)_f$ ,  $(\cdot)_m$ ,  $(\cdot)_v$ , and  $(\cdot)_c$  denote quantities corresponding to the fiber, matrix, void, and composite (as a whole).

**Volume Fraction**  $v_f = \frac{V_f}{V_c}$ ,  $v_m = \frac{V_m}{V_c}$ ,  $v_v = \frac{V_v}{V_c}$  such that  $v_f + v_m + v_v = 1$ .

Note that composite density  $\rho_c = \rho_f v_f + \rho_m v_m$ .

**Weight Fraction**  $w_f = \frac{\rho_f}{\rho_c} v_f$

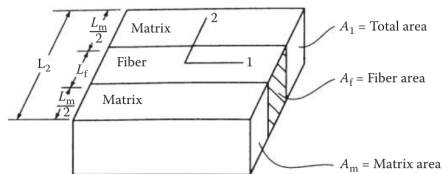

(Figure 3.5a from Gibson 2012)

$$E_1 = v_f E_f + v_m E_m$$

$$(\times) E_2 = \left( \frac{v_f}{E_f} + \frac{v_m}{E_m} \right)^{-1}$$

$$\nu_{12} = v_f \nu_f + v_m \nu_m$$

$$(\times) G_{12} = \left( \frac{v_f}{G_f} + \frac{v_m}{G_m} \right)^{-1}$$

# 3.1. The Rule of Mixtures

## Micro-Mechanics Descriptions

The rule of mixtures is introduced as a very simple framework for developing “overall” **RoM is not always satisfactory!**

### Basic

Subscript matrix,

Volum

Weight

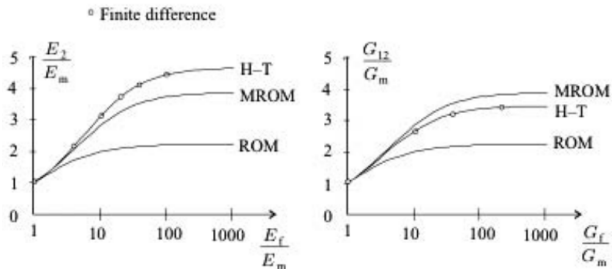
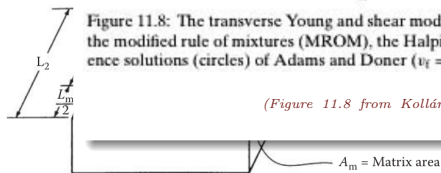

Figure 11.8: The transverse Young and shear moduli calculated by the rule of mixtures (ROM), the modified rule of mixtures (MROM), the Halpin–Tsai (H–T) equations, and the finite difference solutions (circles) of Adams and Doner ( $\nu_f = 0.55$ ).

(Figure 11.8 from Kollár and Springer 2003)



(Figure 3.5a from Gibson 2012)

$$(\times)G_{12} = \left( \frac{\nu_f}{G_f} + \frac{\nu_m}{G_m} \right)^{-1}$$

## 3.1. The Rule of Mixtures

### Micro-Mechanics Descriptions

- The mismatch is related to the fact that our idealized picture was a poor representation of reality to begin with. More geometrical details of the fiber arrangement are necessary.

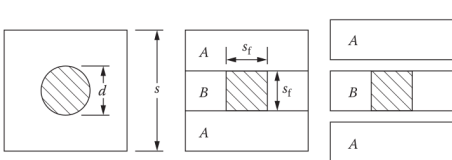

(Figure 3.8 from Gibson 2012)

$$E_{B2} = \left( \frac{\sqrt{v_f}}{E_f} + \frac{1 - \sqrt{v_f}}{E_m} \right)^{-1}$$

$$= \frac{E_m}{1 - \sqrt{v_f} \left( 1 - \frac{E_m}{E_f} \right)}$$

$$E_2 = E_{B2} \frac{s_f}{s} + E_m \frac{s - s_f}{s}$$

$$= E_{B2} \sqrt{v_f} + E_m (1 - \sqrt{v_f})$$

$$s_f = \sqrt{\frac{\pi}{4}} d; s = \sqrt{\frac{\pi}{4v_f}} d.$$

$$= E_m \left[ (1 - \sqrt{v_f}) + \frac{\sqrt{v_f}}{1 - \sqrt{v_f} \left( 1 - \frac{E_m}{E_f} \right)} \right]$$

## 3.1. The Rule of Mixtures

### Micro-Mechanics Descriptions

(Recommended reading: Sec. 3.2.3 in Daniel and Ishai 2006)

### The Halpin-Tsai Equation

$$E_2 = E_m \frac{1 + \xi \eta v_f}{1 - \eta v_f}, \quad \eta = \frac{E_f - E_m}{E_f + \xi E_m}$$

$$= E_m \frac{E_f + \xi E_m + \xi v_f (E_f - E_m)}{E_f + \xi E_m - v_f (E_f - E_m)}$$

**Note:**  $\xi = 2$  for circular section fibers.  $\xi = \frac{2a}{b}$  for rectangular fibers ( $b$  being loaded side).

#### Case 1: $\xi \rightarrow 0$

$$E_2 = \left( \frac{v_f}{E_f} + \frac{1 - v_f}{E_m} \right)^{-1}$$

Series, *Reuss* model.

#### Case 2: $\xi \rightarrow \infty$

$$E_2 = E_f v_f + E_m (1 - v_f)$$

Parallel, *Voigt* model.



# 3.1. The Rule of Mixtures

## Micro-Mechanics Descriptions

### Graphical Comparison for varying $\frac{E_f}{E_m}$

shai 2006)

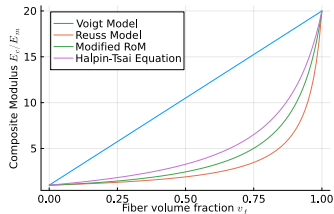
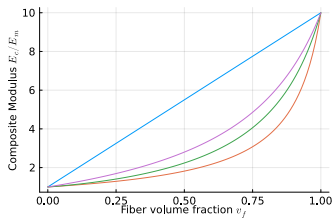
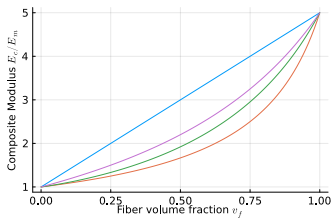

Note:  
side).

loaded

Series, Reuss Model

## 3.2. Numerical Example

### Micro-Mechanics Descriptions

(from Kollár and Springer 2003)

Consider a Graphite/Epoxy unidirectional ply. Matrix properties are given with subscript  $m$  in the table below. Nominal properties with fiber volume fraction  $v_f = 60\%$  are also given. Assume that the fibers show anisotropy ( $E_{f1} \neq E_{f2}$ ).

	$E_1$	$E_2$	$G_{12}$	$\nu_{12}$	$E_m$	$G_m$	$\nu_m$
Value	148	9.65	4.55	0.3	4.1	1.5	0.35

*All moduli in GPa.*

Estimate the following:

- Fiber modulus properties
- Composite material moduli for volume fraction  $v_f = 0.55$ .

(Also discussed sensitivity analysis)

# 4.1. Macro-Mechanics Descriptions

## Material Symmetry and Anisotropy

### Material Symmetry

The study of material symmetry is concerned with finding answers to the question: If the strain field on a deformable object is changed, how does the stress field change?

## 4.1. Macro-Mechanics Descriptions

### Material Symmetry and Anisotropy

#### Material Symmetry

The study of material symmetry is concerned with finding answers to the question: If the strain field on a deformable object is changed, how does the stress field change?

Consider the following Deformation Fields

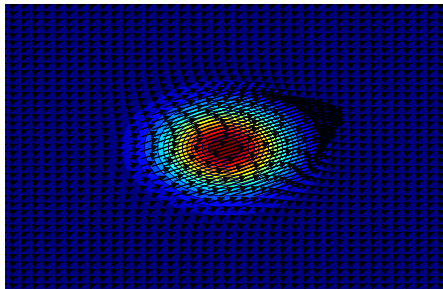

*Deformation Case 1*

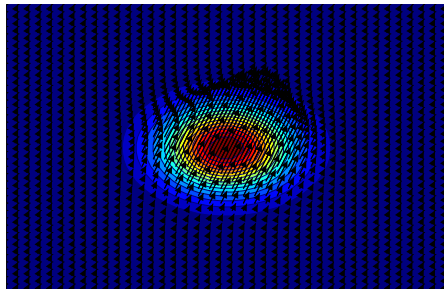

*Deformation Case 2 (Case 1 Rotated)*

# 4.1. Macro-Mechanics Descriptions

## Material Symmetry and Anisotropy

### Material Symmetry

The study of material symmetry is concerned with finding answers to the question: If the strain field on a deformable object is changed, how does the stress field change?

Consider the following Deformation Fields

#### Stress and Strain Field

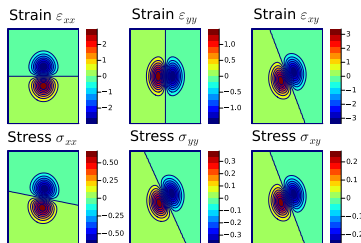

*Isotropic Stress-Strain Relationship*

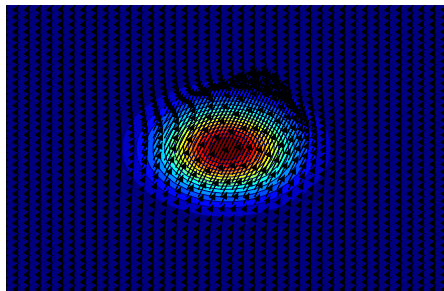

*Deformation Case 2 (Case 1 Rotated)*

# 4.1. Macro-Mechanics Descriptions

## Material Symmetry and Anisotropy

### Material Symmetry

The study of material symmetry is concerned with finding answers to the question: If the strain field on a deformable object is changed, how does the stress field change?

Consider the following Deformation Fields

#### Stress and Strain Field

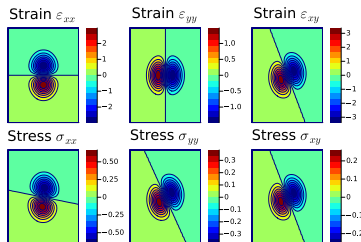

*Isotropic Stress-Strain Relationship*

#### Stress and Strain Field

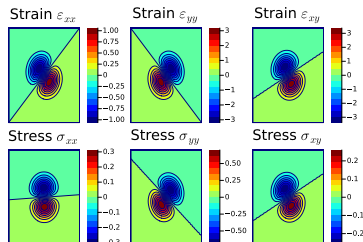

*Isotropic Stress-Strain Relationship*

# 4.1. Macro-Mechanics Descriptions

## Material Symmetry and Anisotropy

### Material Symmetry

The study of material symmetry is concerned with finding answers to the question: If the strain field on a deformable object is changed, how does the stress field change?

Consider the following Deformation Fields

#### Stress and Strain Field

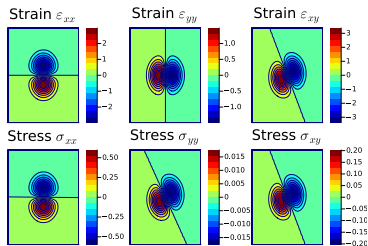

*Anisotropic Case*

#### Stress and Strain Field

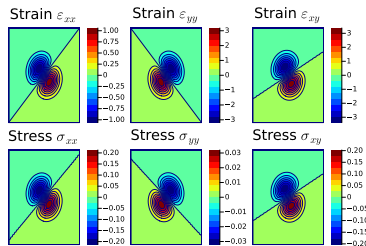

*Anisotropic Case*

# 4.1. Macro-Mechanics Descriptions

## Material Symmetry and Anisotropy

### Material Symmetry

The study of material symmetry is concerned with finding answers to the question: If the strain field on a deformable object is changed, how does the stress field change?

Consider the following Stress and Strain Fields

Stress and Strain Fields

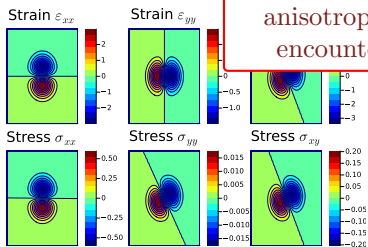

*Anisotropic Case*

Most materials exhibit some sort of symmetry and general anisotropy is almost never encountered in practice.

Stress and Strain Fields

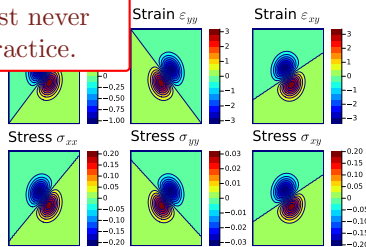

*Anisotropic Case*



# 4.1. Material Symmetry and Anisotropy

## Macro-Mechanics Descriptions

How do stresses and strains transform under coordinate change?

- Suppose  $\underline{x} \in \mathbb{R}^3$  are the coordinates of a point in 3D space.
- Let  $\underline{x}' \in \mathbb{R}^3$  be the coordinates under transformation.
- We will write:  $\underline{x}' = \underline{Q} \underline{x}$ , with  $\underline{Q}^{-1} = \underline{Q}^T$ .

### Strains

- $\underline{\underline{\varepsilon}} = \frac{1}{2} (\nabla_{\underline{x}} \underline{u} + \nabla_{\underline{x}} \underline{u}^T)$
- $\nabla_{\underline{x}'} \underline{u}' = \underline{Q} \nabla_{\underline{x}} \underline{u} \underline{Q}^{-1}$   
 $\implies \underline{\underline{\varepsilon}}' = \underline{Q} \underline{\underline{\varepsilon}} \underline{Q}^T$

### Stresses

- Cauchy Stress Definition:  $\underline{t} = \underline{\underline{\sigma}} \underline{n}$
- $\underline{Q} \underline{t} = \underline{t}' = \underline{\underline{\sigma}}' \underline{n}' = \underline{\underline{\sigma}}' \underline{Q} \underline{n} = \underline{Q} \underline{\underline{\sigma}} \underline{n}$   
 $\implies \underline{\underline{\sigma}}' = \underline{Q} \underline{\underline{\sigma}} \underline{Q}^T$

### Reflections

Note that reflections may be expressed as a coordinate change with

$$\underline{Q} = \begin{bmatrix} 1 & 0 & 0 \\ 0 & 1 & 0 \\ 0 & 0 & -1 \end{bmatrix} \quad (\text{reflection about the } xy \text{ plane}).$$

# 4.1. Material Symmetry and Anisotropy

## Macro-Mechanics Descriptions

- Under reflection about the  $xy$  plane, the strain transforms as,

$$\begin{aligned} \begin{bmatrix} \varepsilon'_x & \frac{\gamma'_{xy}}{2} & \frac{\gamma'_{xz}}{2} \\ \varepsilon'_y & \frac{\gamma'_{yz}}{2} & \varepsilon'_z \\ \text{sym} & & \end{bmatrix} &= \begin{bmatrix} 1 & \cdot & \cdot \\ \cdot & 1 & \cdot \\ \cdot & \cdot & -1 \end{bmatrix} \begin{bmatrix} \varepsilon_x & \frac{\gamma_{xy}}{2} & \frac{\gamma_{xz}}{2} \\ \varepsilon_y & \frac{\gamma_{yz}}{2} & \varepsilon_z \\ \text{sym} & & \end{bmatrix} \begin{bmatrix} 1 & \cdot & \cdot \\ \cdot & 1 & \cdot \\ \cdot & \cdot & -1 \end{bmatrix} \\ &= \begin{bmatrix} \varepsilon_x & \frac{\gamma_{xy}}{2} & -\frac{\gamma_{xz}}{2} \\ \varepsilon_y & -\frac{\gamma_{yz}}{2} & \varepsilon_z \\ \text{sym} & & \end{bmatrix} \end{aligned}$$

- So in Voigt notation we have,

$$\begin{bmatrix} \varepsilon'_x \\ \varepsilon'_y \\ \varepsilon'_z \\ \gamma'_{xy} \\ \gamma'_{xz} \\ \gamma'_{yz} \end{bmatrix} = \begin{bmatrix} 1 & \cdot & \cdot & \cdot & \cdot & \cdot \\ \cdot & 1 & \cdot & \cdot & \cdot & \cdot \\ \cdot & \cdot & 1 & \cdot & \cdot & \cdot \\ \cdot & \cdot & \cdot & 1 & \cdot & \cdot \\ \cdot & \cdot & \cdot & \cdot & -1 & \cdot \\ \cdot & \cdot & \cdot & \cdot & \cdot & -1 \end{bmatrix} \begin{bmatrix} \varepsilon_x \\ \varepsilon_y \\ \varepsilon_z \\ \gamma_{xy} \\ \gamma_{xz} \\ \gamma_{yz} \end{bmatrix} = \begin{bmatrix} 1 & \cdot & \cdot & \cdot & \cdot & \cdot \\ \cdot & 1 & \cdot & \cdot & \cdot & \cdot \\ \cdot & \cdot & 1 & \cdot & \cdot & \cdot \\ \cdot & \cdot & \cdot & 1 & \cdot & \cdot \\ \cdot & \cdot & \cdot & \cdot & -1 & \cdot \\ \cdot & \cdot & \cdot & \cdot & \cdot & -1 \end{bmatrix} \begin{bmatrix} \sigma_x \\ \sigma_y \\ \sigma_z \\ \tau_{xy} \\ \tau_{xz} \\ \tau_{yz} \end{bmatrix}$$

Similarly for Stress

# 4.1. Material Symmetry and Anisotropy

## Macro-Mechanics Descriptions

- Under reflection about the  $xy$  plane, the strain transforms as,

If a material were symmetric about the  $xy$  plane, then reflecting the strain field about the  $xy$  plane will result in a stress field that is reflected about the same  $xy$  plane.

### Note

- Strain field reflection is a kinematic operation/configuration change.
- Change in the Stress field is the effect that the above kinematic change results in.
- If the material happens to be symmetric about the reflection plane, then this change will be a reflection.

$$\begin{bmatrix} \epsilon'_x \\ \epsilon'_y \\ \epsilon'_z \\ \gamma'_{xy} \\ \gamma'_{xz} \\ \gamma'_{yz} \end{bmatrix} = \begin{bmatrix} \cdot & \cdot & \cdot & \cdot & \cdot & \cdot \\ \cdot & \cdot & \cdot & \cdot & \cdot & \cdot \\ \cdot & \cdot & \cdot & \cdot & \cdot & \cdot \\ \cdot & \cdot & \cdot & -1 & \cdot & \cdot \\ \cdot & \cdot & \cdot & \cdot & \cdot & \cdot \\ \cdot & \cdot & \cdot & \cdot & \cdot & -1 \end{bmatrix} \begin{bmatrix} \sigma_x \\ \sigma_y \\ \sigma_z \\ \tau_{xy} \\ \tau_{xz} \\ \tau_{yz} \end{bmatrix}$$

Similarly for Stress

# 4.1. Material Symmetry and Anisotropy

## Macro-Mechanics Descriptions

- We have said the following :

$$\begin{bmatrix} \sigma_x \\ \sigma_y \\ \sigma_z \\ \tau_{xy} \\ \tau_{xz} \\ \tau_{yz} \end{bmatrix} = \begin{bmatrix} C_{11} & C_{12} & C_{13} & C_{14} & C_{15} & C_{16} \\ & C_{22} & C_{23} & C_{24} & C_{25} & C_{26} \\ & & C_{33} & C_{34} & C_{35} & C_{36} \\ & & & C_{44} & C_{45} & C_{46} \\ & & & & C_{55} & C_{56} \\ & & & & & C_{66} \end{bmatrix} \begin{bmatrix} \varepsilon_x \\ \varepsilon_y \\ \varepsilon_z \\ \gamma_{xy} \\ \gamma_{xz} \\ \gamma_{yz} \end{bmatrix}$$

(The  $C_{12}$  to  $C_{16}$  row is circled in red in the original image, with the word "sym" written inside the circle.)

Recall that this symmetry follows from strain energy existence

$$\begin{bmatrix} \sigma'_x \\ \sigma'_y \\ \sigma'_z \\ \tau'_{xy} \\ \tau'_{xz} \\ \tau'_{yz} \end{bmatrix} = \begin{bmatrix} C_{11} & C_{12} & C_{13} & C_{14} & C_{15} & C_{16} \\ & C_{22} & C_{23} & C_{24} & C_{25} & C_{26} \\ & & C_{33} & C_{34} & C_{35} & C_{36} \\ & & & C_{44} & C_{45} & C_{46} \\ & & & & C_{55} & C_{56} \\ & & & & & C_{66} \end{bmatrix} \begin{bmatrix} \varepsilon'_x \\ \varepsilon'_y \\ \varepsilon'_z \\ \gamma'_{xy} \\ \gamma'_{xz} \\ \gamma'_{yz} \end{bmatrix}$$

(The word "sym" is written in the center of the matrix in the original image.)

(The  $\underline{C}$  matrix is the same in both the original and the reflected coordinate systems)

# 4.1. Material Symmetry and Anisotropy

## Macro-Mechanics Descriptions

- We have said the following :

This leads to

$$\begin{bmatrix} C_{11} & C_{12} & C_{13} & C_{14} & -C_{15} & -C_{16} \\ & C_{22} & C_{23} & C_{24} & -C_{25} & -C_{26} \\ & & C_{33} & C_{34} & -C_{35} & -C_{36} \\ & & & C_{44} & -C_{45} & -C_{46} \\ \text{sym} & & & & C_{55} & C_{56} \\ & & & & & C_{66} \end{bmatrix} = \begin{bmatrix} C_{11} & C_{12} & C_{13} & C_{14} & C_{15} & C_{16} \\ & C_{22} & C_{23} & C_{24} & C_{25} & C_{26} \\ & & C_{33} & C_{34} & C_{35} & C_{36} \\ & & & C_{44} & C_{45} & C_{46} \\ \text{sym} & & & & C_{55} & C_{56} \\ & & & & & C_{66} \end{bmatrix}$$

Recall that this symmetry follows from strain energy existence

$$\begin{bmatrix} \sigma'_x \\ \sigma'_y \\ \sigma'_z \\ \tau'_{xy} \\ \tau'_{xz} \\ \tau'_{yz} \end{bmatrix} = \begin{bmatrix} C_{11} & C_{12} & C_{13} & C_{14} & C_{15} & C_{16} \\ & C_{22} & C_{23} & C_{24} & C_{25} & C_{26} \\ & & C_{33} & C_{34} & C_{35} & C_{36} \\ & & & C_{44} & C_{45} & C_{46} \\ \text{sym} & & & & C_{55} & C_{56} \\ & & & & & C_{66} \end{bmatrix} \begin{bmatrix} \varepsilon'_x \\ \varepsilon'_y \\ \varepsilon'_z \\ \gamma'_{xy} \\ \gamma'_{xz} \\ \gamma'_{yz} \end{bmatrix}$$

(The C matrix is the same in both the original and the reflected coordinate systems)

# 4.1. Material Symmetry and Anisotropy

## Macro-Mechanics Descriptions

- We have said the following :

This leads to

$$\begin{bmatrix} C_{11} & C_{12} & C_{13} & C_{14} & -C_{15} & -C_{16} \\ & C_{22} & C_{23} & C_{24} & -C_{25} & -C_{26} \\ & & C_{33} & C_{34} & -C_{35} & -C_{36} \\ & & & C_{44} & -C_{45} & -C_{46} \\ \text{sym} & & & & C_{55} & C_{56} \\ & & & & & C_{66} \end{bmatrix} = \begin{bmatrix} C_{11} & C_{12} & C_{13} & C_{14} & C_{15} & C_{16} \\ & C_{22} & C_{23} & C_{24} & C_{25} & C_{26} \\ & & C_{33} & C_{34} & C_{35} & C_{36} \\ & & & C_{44} & C_{45} & C_{46} \\ \text{sym} & & & & C_{55} & C_{56} \\ & & & & & C_{66} \end{bmatrix}$$

Recall that this symmetry follows from strain energy existence

$$\begin{bmatrix} \sigma'_x \\ \sigma'_y \\ \sigma'_z \\ \tau'_{xy} \\ \tau'_{xz} \\ \tau'_{yz} \end{bmatrix} = \begin{bmatrix} C_{11} & C_{12} & C_{13} & C_{14} & C_{15} & C_{16} \\ & C_{22} & C_{23} & C_{24} & C_{25} & C_{26} \\ & & C_{33} & C_{34} & C_{35} & C_{36} \\ & & & C_{44} & C_{45} & C_{46} \\ \text{sym} & & & & C_{55} & C_{56} \\ & & & & & C_{66} \end{bmatrix} \begin{bmatrix} \varepsilon'_x \\ \varepsilon'_y \\ \varepsilon'_z \\ \gamma'_{xy} \\ \gamma'_{xz} \\ \gamma'_{yz} \end{bmatrix}$$

(The C matrix is the same in both the original and the reflected coordinate systems)

# 4.1. Material Symmetry and Anisotropy

## Macro-Mechanics Descriptions

- We have said the following :

This leads to

$$\begin{bmatrix} C_{11} & C_{12} & C_{13} & C_{14} & -C_{15} & -C_{16} \\ & C_{22} & C_{23} & C_{24} & -C_{25} & -C_{26} \\ & & C_{33} & C_{34} & -C_{35} & -C_{36} \\ & & & C_{44} & -C_{45} & -C_{46} \\ \text{sym} & & & & C_{55} & C_{56} \\ & & & & & C_{66} \end{bmatrix} = \begin{bmatrix} C_{11} & C_{12} & C_{13} & C_{14} & C_{15} & C_{16} \\ & C_{22} & C_{23} & C_{24} & C_{25} & C_{26} \\ & & C_{33} & C_{34} & C_{35} & C_{36} \\ & & & C_{44} & C_{45} & C_{46} \\ \text{sym} & & & & C_{55} & C_{56} \\ & & & & & C_{66} \end{bmatrix}$$

Finally we see that material symmetry about the  $xz$  plane implies the following simplification to the constitutive relationship.

$$\begin{bmatrix} \sigma_x \\ \sigma_y \\ \sigma_z \\ \tau_{xy} \\ \tau_{xz} \\ \tau_{yz} \end{bmatrix} = \begin{bmatrix} C_{11} & C_{12} & C_{13} & C_{14} & 0 & 0 \\ & C_{22} & C_{23} & C_{24} & 0 & 0 \\ & & C_{33} & C_{34} & 0 & 0 \\ & & & C_{44} & 0 & 0 \\ \text{sym} & & & & C_{55} & C_{56} \\ & & & & & C_{66} \end{bmatrix} \begin{bmatrix} \varepsilon_x \\ \varepsilon_y \\ \varepsilon_z \\ \gamma_{xy} \\ \gamma_{xz} \\ \gamma_{yz} \end{bmatrix}$$

This is known as a **Monoclinic Material** (13 constants). This is also quite rare to encounter in practice.

# 4.1. Material Symmetry and Anisotropy

## Macro-Mechanics Descriptions

Suppose all the three fundamental planes are planes of symmetry, we have an **Orthotropic Material** (9 constants).

$$\begin{bmatrix} \sigma_x \\ \sigma_y \\ \sigma_z \\ \tau_{xy} \\ \tau_{xz} \\ \tau_{yz} \end{bmatrix} = \begin{bmatrix} C_{11} & C_{12} & C_{13} & 0 & 0 & 0 \\ & C_{22} & C_{23} & 0 & 0 & 0 \\ & & C_{33} & 0 & 0 & 0 \\ & & & C_{44} & 0 & 0 \\ \text{sym} & & & & C_{55} & 0 \\ & & & & & C_{66} \end{bmatrix} \begin{bmatrix} \varepsilon_x \\ \varepsilon_y \\ \varepsilon_z \\ \gamma_{xy} \\ \gamma_{xz} \\ \gamma_{yz} \end{bmatrix}$$

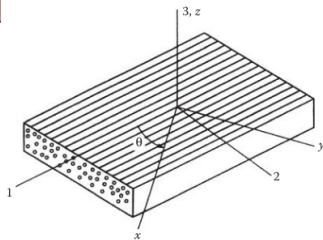

(Figure 2.5 from Gibson 2012)



## 4.1. Material Symmetry and Anisotropy

### Macro-Mechanics Descriptions

Suppose all the three fundamental planes are planes of symmetry, we have an **Orthotropic Material** (9 constants).

$$\begin{bmatrix} \sigma_x \\ \sigma_y \\ \sigma_z \\ \tau_{xy} \\ \tau_{yz} \\ \tau_{zx} \end{bmatrix} = \begin{bmatrix} C_{11} & C_{12} & C_{13} & 0 & 0 & 0 \\ & C_{22} & C_{23} & 0 & 0 & 0 \\ & & C_{33} & 0 & 0 & 0 \\ & & & C_{44} & 0 & 0 \\ & & & & C_{55} & 0 \\ & & & & & C_{66} \end{bmatrix} \begin{bmatrix} \varepsilon_x \\ \varepsilon_y \\ \varepsilon_z \\ \gamma_{xy} \\ \gamma_{yz} \\ \gamma_{zx} \end{bmatrix}$$

Notice that  $(\sigma_{(x,y,z)}, \varepsilon_{(x,y,z)})$  and  $(\tau_{(xy,xz,yz)}, \gamma_{(xy,xz,yz)})$  are naturally decoupled as a consequence of symmetry in this coordinate system.

Also note,

- Specially orthotropic
- Generally orthotropic

(Figure 2.5 from Gibson 2012)

# 4.1. Material Symmetry and Anisotropy: Transverse Isotropy

## Macro-Mechanics Descriptions

- In continuous fiber reinforced composites, it is often the case that the fibers are randomly distributed on a plane. This leads to planar isotropy in the plane perpendicular to the fiber stacking direction.

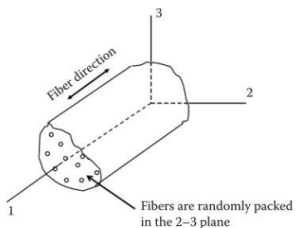

(Figure 2.6 from Gibson 2012)

- How do the stresses and strains transform on the plane?

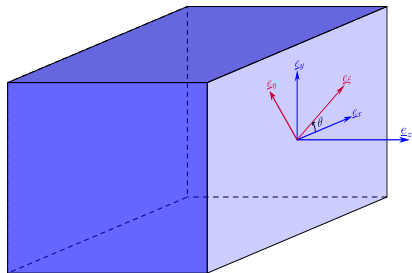

$$\begin{aligned}
 (\sigma_x, \sigma_y, \sigma_z, \tau_{xy}, \tau_{xz}, \tau_{yz}) &\rightarrow (\sigma_\xi, \sigma_\eta, \sigma_z, \tau_{\xi\eta}, \tau_{\xi z}, \tau_{\eta z}) \\
 (\epsilon_x, \epsilon_y, \epsilon_z, \gamma_{xy}, \gamma_{xz}, \gamma_{yz}) &\rightarrow (\epsilon_\xi, \epsilon_\eta, \epsilon_z, \gamma_{\xi\eta}, \gamma_{\xi z}, \gamma_{\eta z})
 \end{aligned}$$

# 4.1. Material Symmetry and Anisotropy

## Macro-Mechanics Descriptions

- The stresses and strains transform as follows on the plane:

$$\sigma_{\xi} = \frac{\sigma_x + \sigma_y}{2} + \frac{\sigma_x - \sigma_y}{2} \cos 2\theta + \tau_{xy} \sin 2\theta$$

$$\sigma_{\eta} = \frac{\sigma_x + \sigma_y}{2} - \frac{\sigma_x - \sigma_y}{2} \cos 2\theta - \tau_{xy} \sin 2\theta$$

$$(\sigma_z = \sigma_z)$$

$$\tau_{\xi\eta} = -\frac{\sigma_x - \sigma_y}{2} \sin 2\theta + \tau_{xy} \cos 2\theta$$

$$\tau_{\xi z} = \tau_{xz} \cos \theta + \tau_{yz} \sin \theta$$

$$\tau_{\eta z} = -\tau_{xz} \sin \theta + \tau_{yz} \cos \theta$$

$$\varepsilon_{\xi} = \frac{\varepsilon_x + \varepsilon_y}{2} + \frac{\varepsilon_x - \varepsilon_y}{2} \cos 2\theta + \frac{\gamma_{xy}}{2} \sin 2\theta$$

$$\varepsilon_{\eta} = \frac{\varepsilon_x + \varepsilon_y}{2} - \frac{\varepsilon_x - \varepsilon_y}{2} \cos 2\theta - \frac{\gamma_{xy}}{2} \sin 2\theta$$

$$(\varepsilon_z = \varepsilon_z)$$

$$\gamma_{\xi\eta} = -(\varepsilon_x - \varepsilon_y) \sin 2\theta + \gamma_{xy} \cos 2\theta$$

$$\gamma_{\xi z} = \gamma_{xz} \cos \theta + \gamma_{yz} \sin \theta$$

$$\gamma_{\eta z} = -\gamma_{xz} \sin \theta + \gamma_{yz} \cos \theta$$

- For an orthotropic material, the straight stresses/strains and shear stresses/strains are fully decoupled.
- So we will consider different cases of kinematic deformation fields to see if more can be said.

# 4.1. Material Symmetry and Anisotropy

Macro-Mech

## 1. Pure Out-Of-Plane Shear ( $\gamma_{xz} \neq 0$ )

- The stresses and strains are,

- The

$$\begin{aligned} \sigma_\xi &= 0 & \varepsilon_\xi &= 0 \\ \sigma_\eta &= 0 & \varepsilon_\eta &= 0 \\ \sigma_z &= 0 & \varepsilon_z &= 0 \\ \tau_{\xi\eta} &= 0 & \gamma_{\xi\eta} &= 0 \end{aligned}$$

$$\begin{aligned} \sigma_\eta &= \begin{bmatrix} \tau_{\xi z} \\ \tau_{\eta z} \end{bmatrix} = \begin{bmatrix} \cos \theta & \sin \theta \\ -\sin \theta & \cos \theta \end{bmatrix} \begin{bmatrix} \tau_{xz} \\ \tau_{yz} \end{bmatrix} \\ (\sigma_z = 0) & \\ \tau_{\xi\eta} &= \begin{bmatrix} C_{55}\gamma_{xz} \cos \theta \\ -C_{55}\gamma_{xz} \sin \theta \end{bmatrix} := \begin{bmatrix} C_{55}\gamma_{\xi\eta} \\ C_{66}\gamma_{\eta z} \end{bmatrix} \end{aligned}$$

$$\begin{aligned} \begin{bmatrix} \gamma_{\xi z} \\ \gamma_{\eta z} \end{bmatrix} &= \begin{bmatrix} \gamma_{xz} \cos \theta \\ -\gamma_{xz} \sin \theta \end{bmatrix} \end{aligned}$$

- Under symmetry,  $(\tau_{\xi z}, \tau_{\eta z})$  is related to  $(\gamma_{\xi z}, \gamma_{\eta z})$  in the same way that  $(\tau_{xz}, \tau_{yz})$  is related to  $(\gamma_{xz}, \gamma_{yz})$ .

- So we have,

$$\begin{bmatrix} C_{11} & C_{12} & C_{13} & 0 & 0 & 0 \\ & C_{22} & C_{23} & 0 & 0 & 0 \\ & & C_{33} & 0 & 0 & 0 \\ & & & C_{44} & 0 & 0 \\ & \text{sym} & & & C_{55} & 0 \\ & & & & & C_{66} \end{bmatrix}$$

o see if

## 4.1. M

Macro-Mech

2. Pure Out-Of-Plane Stretch ( $\varepsilon_z \neq 0$ )

- We have straight stresses  $\sigma_x = C_{13}\varepsilon_z, \sigma_y = C_{23}\varepsilon_z$ .
- Upon transformation we have,

$$\sigma_\xi = \left( \frac{C_{13} + C_{23}}{2} + \frac{C_{13} - C_{23}}{2} \cos 2\theta \right) \varepsilon_z$$

$$\sigma_\eta = \left( \frac{C_{13} + C_{23}}{2} - \frac{C_{13} - C_{23}}{2} \cos 2\theta \right) \varepsilon_z$$

$$\sigma_z = \sigma_z$$

$$\tau_{\xi\eta} = -\frac{C_{13} - C_{23}}{2} \sin 2\theta$$

$$\tau_{\xi z} = \tau_{\eta z} = 0$$

$$\varepsilon_\xi = 0$$

$$\varepsilon_\eta = 0$$

$$\varepsilon_z = \varepsilon_z$$

$$\gamma_{\xi\eta} = 0$$

$$\gamma_{\xi z} = \gamma_{\eta z} = 0$$

- For planar isotropy, the relationship between  $(\sigma_\xi, \sigma_\eta)$  and  $\sigma_z$  must be independent of  $\theta$ . This is only possible for  $C_{13} = C_{23}$ .

- So we have,

$$\begin{bmatrix} C_{11} & C_{12} & C_{13} & 0 & 0 & 0 \\ & C_{22} & C_{23} & 0 & 0 & 0 \\ & & C_{33} & 0 & 0 & 0 \\ & & & C_{44} & 0 & 0 \\ \text{sym} & & & & C_{55} & 0 \end{bmatrix}$$

• Th

 $\sigma_\xi = \sigma$  $\sigma_\eta = \sigma$  $(\sigma_z = \sigma$  $\tau_{\xi\eta} = -$  $\tau_{\xi z} = \tau_{\eta z} = -$  $\tau_{\eta z} = -$ 

• For

str

• So

mo

 $y \sin 2\theta$  $y \sin 2\theta$ 

to see if

## 4.1. Material Symmetry and Anisotropy

Macro-Me

3. Pure In-Plane Stretch ( $\varepsilon_x \neq 0, \varepsilon_y = 0$ )

- From the constitutive properties we have  $\sigma_x = C_{11}\varepsilon_x$  and  $\sigma_y = C_{12}\varepsilon_x$ .
- Using this all the other components can be written as

$$\begin{aligned} \sigma_\xi &= \left( \frac{C_{11} + C_{12}}{2} + \frac{C_{11} - C_{12}}{2} \cos 2\theta \right) \varepsilon_x & \varepsilon_\xi &= \frac{1 + \cos 2\theta}{2} \varepsilon_x \\ \sigma_\eta &= \left( \frac{C_{11} + C_{12}}{2} + \frac{C_{11} - C_{12}}{2} \cos 2\theta \right) \varepsilon_x & \varepsilon_\eta &= \frac{1 - \cos 2\theta}{2} \varepsilon_x \\ (\sigma_z &= C_{12}\varepsilon_x + C_{22}\varepsilon_y & \varepsilon_z &= 0 \\ \tau_{\xi\eta} &= \sigma_z = 0 & \gamma_{\xi\eta} &= 0 \\ \tau_{\xi z} &= \tau_{\xi\eta} = 0 & \gamma_{\xi z} &= \gamma_{\eta z} = 0. \\ \tau_{\eta z} &= \tau_{\xi z} = \tau_{\eta z} = 0. & & \end{aligned}$$

- For the  $\sigma_\eta$  equality to hold, we need  $C_{22} = C_{11}$ . So we have

$$\begin{bmatrix} C_{11} & C_{12} & C_{13} & 0 & 0 & 0 \\ & C_{22} & C_{13} & 0 & 0 & 0 \\ & & C_{33} & 0 & 0 & 0 \\ & & & C_{44} & 0 & 0 \\ & \text{sym} & & & C_{55} & 0 \\ & & & & & C_{55} \end{bmatrix}$$

to see if

# 4.1. Material Symmetry and Anisotropy

## Macro-Mechanics Descriptions

### 4. Pure In-Plane Shear ( $\gamma_{xy} \neq 0$ )

- From the constitutive properties we have  $\tau_{xy} = C_{44}\gamma_{xy}$ .
- Using this all the other components can be written as

$$\begin{array}{l}
 \sigma_\xi = C_{44}\gamma_{xy} \sin 2\theta = C_{11}\varepsilon_\xi + C_{12}\varepsilon_\eta \\
 \sigma_\eta = -C_{44}\gamma_{xy} \sin 2\theta = C_{12}\varepsilon_\xi + C_{11}\varepsilon_\eta \\
 (\sigma_z = 0 \\
 \tau_{\xi\eta} = C_{44}\gamma_{xy} \cos 2\theta \\
 \tau_{\xi z} = \tau_{\eta z} = 0.
 \end{array}
 \qquad
 \begin{array}{l}
 \varepsilon_\xi = \frac{\gamma_{xy}}{2} \sin 2\theta \\
 \varepsilon_\eta = -\frac{\gamma_{xy}}{2} \sin 2\theta \\
 \varepsilon_z = 0 \\
 \gamma_{\xi\eta} = \gamma_{xy} \cos 2\theta \\
 \gamma_{\xi z} = \gamma_{\eta z} = 0.
 \end{array}$$

- So we have  $C_{44}\gamma_{xy} \sin 2\theta = \frac{C_{11}-C_{12}}{2}\gamma_{xy} \sin 2\theta$ . Therefore,

$$\begin{bmatrix}
 C_{11} & C_{12} & C_{13} & 0 & 0 & 0 \\
 & C_{11} & C_{13} & 0 & 0 & 0 \\
 & & C_{33} & 0 & 0 & 0 \\
 & & & \frac{C_{11}-C_{12}}{2} & 0 & 0 \\
 & & & & C_{44} & 0 \\
 & \text{sym} & & & & C_{55}
 \end{bmatrix}$$

$$\frac{\gamma_{xy}}{2} \sin 2\theta$$

$$\frac{\gamma_{xy}}{2} \sin 2\theta$$

$\theta$

ar

s to see if

# 4.1. Material Symmetry and Anisotropy

## Macro-Mechanics Descriptions

- The stresses and strains transform as follows on the plane:

To Summarize,

a **Transversely Isotropic Material**  
constitution can be expressed as

$$\begin{matrix} \sigma_\xi \\ \sigma_\eta \\ (\sigma_z \\ \tau_{\xi\eta} \\ \tau_{\xi z} \\ \tau_{\eta z} \end{matrix} \begin{bmatrix} \sigma_x \\ \sigma_y \\ \sigma_z \\ \tau_{xy} \\ \tau_{xz} \\ \tau_{yz} \end{bmatrix} = \begin{bmatrix} C_{11} & C_{12} & C_{13} & 0 & 0 & 0 \\ & C_{11} & C_{13} & 0 & 0 & 0 \\ & & C_{33} & 0 & 0 & 0 \\ & & & \frac{C_{11}-C_{12}}{2} & 0 & 0 \\ & \text{sym} & & & C_{55} & 0 \\ & & & & & C_{55} \end{bmatrix} \begin{bmatrix} \varepsilon_x \\ \varepsilon_y \\ \varepsilon_z \\ \gamma_{xy} \\ \gamma_{xz} \\ \gamma_{yz} \end{bmatrix}$$

The material is fully characterized by five engineering constants.



## 4.1. Material Symmetry and Anisotropy: Engineering Constants

### Macro-Mechanics Descriptions

- In engineering practice, the constants are usually written easier in terms of compliance.
- For a specially orthotropic material the strain-stress relationship are usually expressed as,

$$\begin{bmatrix} \varepsilon_x \\ \varepsilon_y \\ \varepsilon_z \\ \gamma_{xy} \\ \gamma_{xz} \\ \gamma_{yz} \end{bmatrix} = \begin{bmatrix} \frac{1}{E_{11}} & -\frac{\nu_{21}}{E_{22}} & -\frac{\nu_{31}}{E_{33}} & 0 & 0 & 0 \\ -\frac{\nu_{12}}{E_{11}} & \frac{1}{E_{22}} & -\frac{\nu_{32}}{E_{33}} & 0 & 0 & 0 \\ -\frac{\nu_{13}}{E_{11}} & -\frac{\nu_{23}}{E_{22}} & \frac{1}{E_{33}} & 0 & 0 & 0 \\ & & & \frac{1}{G_{12}} & 0 & 0 \\ & \text{sym} & & & \frac{1}{G_{13}} & 0 \\ & & & & & \frac{1}{G_{23}} \end{bmatrix} \begin{bmatrix} \sigma_x \\ \sigma_y \\ \sigma_z \\ \tau_{xy} \\ \tau_{xz} \\ \tau_{yz} \end{bmatrix}$$

## 5. Analysis of Planar Laminates

- Let us just consider one thin layer of a transversely isotropic material (continuously reinforced composite along a single direction).

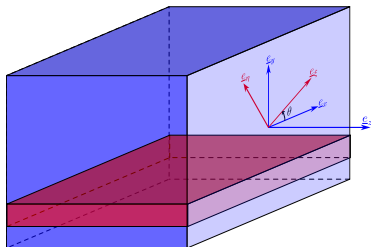

$$\begin{bmatrix} \sigma_x \\ \sigma_y \\ \sigma_z \\ \tau_{xy} \\ \tau_{xz} \\ \tau_{yz} \end{bmatrix} = \begin{bmatrix} C_{11} & C_{12} & C_{13} & 0 & 0 & 0 \\ & C_{11} & C_{13} & 0 & 0 & 0 \\ & & C_{33} & 0 & 0 & 0 \\ & & & \frac{C_{11}-C_{12}}{2} & 0 & 0 \\ & \text{sym} & & & C_{55} & 0 \\ & & & & & C_{55} \end{bmatrix} \begin{bmatrix} \varepsilon_x \\ \varepsilon_y \\ \varepsilon_z \\ \gamma_{xy} \\ \gamma_{xz} \\ \gamma_{yz} \end{bmatrix}$$

## 5. Analysis of Planar Laminates

- Let us just consider one thin layer of a transversely isotropic material (continuously reinforced composite along a single direction).

$$\begin{bmatrix} \sigma_x \\ \sigma_y \\ \sigma_z \\ \tau_{xy} \\ \tau_{xz} \\ \tau_{yz} \end{bmatrix} = \begin{bmatrix} C_{11} & C_{12} & C_{13} & 0 & 0 & 0 \\ & C_{11} & C_{13} & 0 & 0 & 0 \\ & & C_{33} & 0 & 0 & 0 \\ & & & \frac{C_{11}-C_{12}}{2} & 0 & 0 \\ & \text{sym} & & & C_{55} & 0 \\ & & & & & C_{55} \end{bmatrix} \begin{bmatrix} \varepsilon_x \\ \varepsilon_y \\ \varepsilon_z \\ \gamma_{xy} \\ \gamma_{xz} \\ \gamma_{yz} \end{bmatrix}$$

- We invoke plane stress assumptions, setting  $\sigma_z = 0$ . Let us also assume small shears,  $\tau_{xz} = 0, \tau_{yz} = 0$ .

(Note:  $\varepsilon_z$  is not zero, and is implicitly defined)

$$\begin{bmatrix} \sigma_1 \\ \sigma_2 \\ \tau_{12} \end{bmatrix} = \begin{bmatrix} C_{11} & C_{12} & 0 \\ C_{12} & C_{22} & 0 \\ 0 & 0 & C_{33} \end{bmatrix} \begin{bmatrix} \varepsilon_1 \\ \varepsilon_2 \\ \gamma_{12} \end{bmatrix} \quad \begin{array}{l} (4 \text{ constants}) \\ \text{(Note change in notation in } C_{ij}) \end{array}$$

# 5.1. Generally Orthotropic Laminates

## Analysis of Planar Laminates

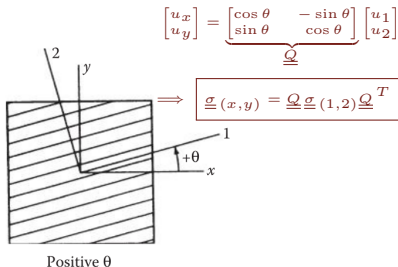

(Figure 2.11 from Gibson 2012)

- What if the coordinate system is not aligned with the fiber axes?  
**The stress and strains transform**
- In the constitutive relationship we have,

$$\underline{\sigma}_{(1,2)} = \underline{C} \underline{\varepsilon}_{(1,2)}$$

$$\underline{T}_{\sigma}^{-1} \underline{\sigma}_{(x,y)} = \underline{\sigma}_{(1,2)} = \underline{C} \underline{\varepsilon}_{(1,2)} = \underline{C} \underline{T}_{\varepsilon}^{-1} \underline{\varepsilon}_{(x,y)}$$

$$\Rightarrow \underline{\sigma}_{(x,y)} = \underbrace{\underline{T}_{\sigma} \underline{C} \underline{T}_{\varepsilon}^{-1}}_{\underline{C}' } \underline{\varepsilon}_{(x,y)}$$

where

$$\underline{C} = \begin{bmatrix} C_{11} & C_{12} & 0 \\ C_{12} & C_{22} & 0 \\ 0 & 0 & C_{33} \end{bmatrix}.$$

$$\begin{bmatrix} \sigma_x \\ \sigma_y \\ \tau_{xy} \end{bmatrix} = \underbrace{\begin{bmatrix} \cos^2 \theta & \sin^2 \theta & -2 \cos \theta \sin \theta \\ \sin^2 \theta & \cos^2 \theta & 2 \cos \theta \sin \theta \\ \cos \theta \sin \theta & -\cos \theta \sin \theta & \cos^2 \theta - \sin^2 \theta \end{bmatrix}}_{\underline{T}_{\sigma}} \begin{bmatrix} \sigma_1 \\ \sigma_2 \\ \tau_{12} \end{bmatrix}$$

$$\underline{T}_{\sigma}^{-1} = \begin{bmatrix} \cos^2 \theta & \sin^2 \theta & 2 \cos \theta \sin \theta \\ \sin^2 \theta & \cos^2 \theta & -2 \cos \theta \sin \theta \\ -\cos \theta \sin \theta & \cos \theta \sin \theta & \cos^2 \theta - \sin^2 \theta \end{bmatrix}$$

# 5.1. Generally Orthotropic Laminates

## Analysis of Planar Laminates

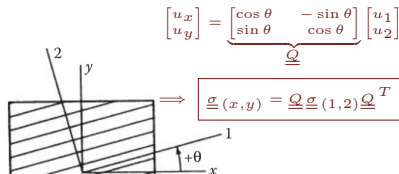

- What if the coordinate system is not aligned with the fiber axes?  
**The stress and strains transform**
- In the constitutive relationship we

Note that Strain Transformation looks slightly different because of our definition of shear strain  $\gamma_{xy} = 2\varepsilon_{xy}$ .

$$\begin{bmatrix} \varepsilon_x \\ \varepsilon_y \\ \gamma_{xy} \end{bmatrix} = \underbrace{\begin{bmatrix} \cos^2 \theta & \sin^2 \theta & -\cos \theta \sin \theta \\ \sin^2 \theta & \cos^2 \theta & \cos \theta \sin \theta \\ 2 \cos \theta \sin \theta & -2 \cos \theta \sin \theta & \cos^2 \theta - \sin^2 \theta \end{bmatrix}}_{\underline{\underline{T}}_\varepsilon} \begin{bmatrix} \varepsilon_1 \\ \varepsilon_2 \\ \gamma_{12} \end{bmatrix}$$

$$\begin{bmatrix} \sigma_x \\ \sigma_y \\ \tau_{xy} \end{bmatrix} = \underbrace{\begin{bmatrix} \sin^2 \theta & \cos^2 \theta & 2 \cos \theta \sin \theta \\ \cos \theta \sin \theta & -\cos \theta \sin \theta & \cos^2 \theta - \sin^2 \theta \end{bmatrix}}_{\underline{\underline{T}}_\sigma} \begin{bmatrix} \tau_{12} \end{bmatrix} \quad \text{where}$$

$$\underline{\underline{T}}_\sigma^{-1} = \begin{bmatrix} \cos^2 \theta & \sin^2 \theta & 2 \cos \theta \sin \theta \\ \sin^2 \theta & \cos^2 \theta & -2 \cos \theta \sin \theta \\ -\cos \theta \sin \theta & \cos \theta \sin \theta & \cos^2 \theta - \sin^2 \theta \end{bmatrix}$$

$$\begin{aligned} \sigma_{(1,2)} &= \underline{\underline{C}} \varepsilon_{(1,2)} \\ \sigma_{(x,y)} &= \sigma_{(1,2)} = \underline{\underline{C}} \varepsilon_{(1,2)} = \underline{\underline{C}} \underline{\underline{T}}_\varepsilon^{-1} \varepsilon_{(x,y)} \\ \Rightarrow \sigma_{(x,y)} &= \underbrace{\underline{\underline{T}}_\sigma \underline{\underline{C}} \underline{\underline{T}}_\varepsilon^{-1}}_{\underline{\underline{C}}'} \varepsilon_{(x,y)} \end{aligned}$$

$$\underline{\underline{C}} = \begin{bmatrix} C_{11} & C_{12} & 0 \\ C_{12} & C_{22} & 0 \\ 0 & 0 & C_{33} \end{bmatrix}.$$

# 5.1. Generally Orthotropic Laminates

## Analysis of Planar Laminates

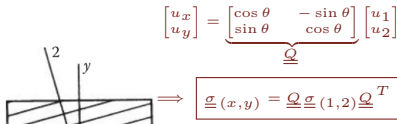

- What if the coordinate system is not aligned with the fiber axes?

**Transformed  $\underline{C}$  Matrix ( $\underline{\sigma} = \underline{C} \underline{\varepsilon}$ )**

$$\underline{C}' = \begin{bmatrix} C'_{11} & C'_{12} & C'_{13} \\ C'_{12} & C'_{22} & C'_{23} \\ C'_{13} & C'_{23} & C'_{33} \end{bmatrix}$$

$$C'_{11} = C_{11}c^4 + C_{22}s^4 + (2C_{33} + C_{12})2c^2s^2$$

$$C'_{22} = C_{11}s^4 + C_{22}c^4 + (2C_{33} + C_{12})2c^2s^2$$

$$C'_{33} = (C_{11} + C_{22} - 2C_{33} - 2C_{12})c^2s^2 + C_{33}(c^4 + s^4)$$

$$C'_{12} = (C_{11} + C_{22} - 4C_{33})c^2s^2 + C_{12}(c^4 + s^4)$$

$$C'_{13} = (C_{11} - 2C_{33} - C_{12})c^3s - (C_{22} - 2C_{33} - C_{12})cs^3$$

$$C'_{23} = (C_{11} - 2C_{33} - C_{12})cs^3 - (C_{22} - 2C_{33} - C_{12})c^3s.$$

$$\begin{bmatrix} \sigma \\ \sigma \\ \tau_{xy} \end{bmatrix}$$

$$\underline{T}_{\sigma}^{-1} = \begin{bmatrix} \cos^2 \theta & \sin^2 \theta & 2 \cos \theta \sin \theta \\ \sin^2 \theta & \cos^2 \theta & -2 \cos \theta \sin \theta \\ -\cos \theta \sin \theta & \cos \theta \sin \theta & \cos^2 \theta - \sin^2 \theta \end{bmatrix}$$

stress and strains transform  
the constitutive relationship we

$$\underline{\sigma}_{(1,2)} = \underline{C} \underline{\varepsilon}_{(1,2)}$$

$$\underline{\sigma}_{(x,y)} = \underline{\sigma}_{(1,2)} = \underline{C} \underline{\varepsilon}_{(1,2)} = \underline{C} \underline{T}_{\varepsilon}^{-1} \underline{\varepsilon}_{(x,y)}$$

$$\Rightarrow \underline{\sigma}_{(x,y)} = \underbrace{\underline{T}_{\sigma} \underline{C} \underline{T}_{\varepsilon}^{-1}}_{\underline{C}'} \underline{\varepsilon}_{(x,y)}$$

$$\underline{C} = \begin{bmatrix} C_{11} & C_{12} & 0 \\ C_{12} & C_{22} & 0 \\ 0 & 0 & C_{33} \end{bmatrix}.$$

# 5.1. Generally Orthotropic Laminates

## Analysis of Planar Laminates

- Compliance is often more convenient:
- Based on this we can write,

$$\underline{\varepsilon}(x, y) = \underline{T} \underline{\varepsilon} \underline{T}^{-1} \underline{\sigma}(x, y)$$

$$\begin{bmatrix} \varepsilon_x \\ \varepsilon_y \\ \gamma_{xy} \end{bmatrix} = \begin{bmatrix} S'_{11} & S'_{12} & S'_{13} \\ & S'_{22} & S'_{23} \\ & & S'_{33} \end{bmatrix} \begin{bmatrix} \sigma_x \\ \sigma_y \\ \tau_{xy} \end{bmatrix}$$

$$S'_{11} = S_{11}c^4 + S_{22}s^4 + (S_{33} + 2S_{12})c^2s^2$$

$$S'_{22} = S_{11}s^4 + S_{22}c^4 + (S_{33} + 2S_{12})c^2s^2$$

$$S'_{33} = (2S_{11} + 2S_{22} - S_{33} - 4S_{12})2c^2s^2 + S_{33}(c^4 + s^4)$$

$$S'_{12} = (S_{11} + S_{22} - S_{33})c^2s^2 + S_{12}(c^4 + s^4)$$

$$S'_{13} = (2S_{11} - S_{33} - 2S_{12})c^3s - (2S_{22} - S_{33} - 2S_{12})cs^3$$

$$S'_{23} = (2S_{11} - S_{33} - 2S_{12})cs^3 - (2S_{22} - S_{33} - 2S_{12})c^3s.$$

$$E_x = \left[ \frac{c^4}{E_1} + \frac{s^4}{E_2} + \left( \frac{1}{G_{12}} - \frac{2\nu_{21}}{E_2} \right) c^2s^2 \right]^{-1}$$

$$E_y = \left[ \frac{s^4}{E_1} + \frac{c^4}{E_2} + \left( \frac{1}{G_{12}} - \frac{2\nu_{21}}{E_2} \right) c^2s^2 \right]^{-1}$$

$$G_{xy} = \left[ \frac{c^4 + s^4}{G_{12}} + \left( \frac{1}{E_1} + \frac{1}{E_2} - \frac{1}{2G_{12}} - 2\frac{\nu_{21}}{E_2} \right) 4c^2s^2 \right]^{-1}$$

$$\nu_{yx} = E_y \left[ \frac{\nu_{21}}{E_2} (c^4 + s^4) \right]$$

$$- \left( \frac{1}{E_1} + \frac{1}{E_2} - \frac{1}{G_{12}} \right) c^2s^2$$

- In the material principal directions we have,

$$\begin{bmatrix} \varepsilon_1 \\ \varepsilon_2 \\ \gamma_{12} \end{bmatrix} = \begin{bmatrix} \frac{1}{E_1} & -\frac{\nu_{21}}{E_2} & 0 \\ -\frac{\nu_{12}}{E_1} & \frac{1}{E_2} & 0 \\ 0 & 0 & \frac{1}{G_{12}} \end{bmatrix} \begin{bmatrix} \sigma_1 \\ \sigma_2 \\ \tau_{12} \end{bmatrix}$$

Engineering Constants:  $E_1, E_2, G_{12}, \nu_{12}$

- It is customary to express the laminate constitutive relationship as

$$\begin{bmatrix} \varepsilon_x \\ \varepsilon_y \\ \gamma_{xy} \end{bmatrix} = \begin{bmatrix} \frac{1}{E_x} & -\frac{\nu_{yx}}{E_y} & \frac{\eta_{xy,x}}{G_{xy}} \\ -\frac{\nu_{xy}}{E_x} & \frac{1}{E_y} & \frac{\eta_{xy,y}}{G_{xy}} \\ \frac{\eta_{x,xy}}{E_x} & \frac{\eta_{y,xy}}{E_y} & \frac{1}{G_{xy}} \end{bmatrix} \begin{bmatrix} \sigma_x \\ \sigma_y \\ \tau_{xy} \end{bmatrix}$$

# 5.1. Generally Orthotropic Laminates

## Analysis of Planar Laminates

- Compliance is often more convenient
  - Based on this we can write, The Shear Constants can be written as

$$\underline{\varepsilon}(x,y) = \underline{T} \underline{\varepsilon} \underline{T}^{-1} \underline{\sigma}(x,y)$$

$$\begin{bmatrix} \varepsilon_x \\ \varepsilon_y \\ \gamma_{xy} \end{bmatrix} = \begin{bmatrix} S'_{11} & S'_{12} & S'_{13} \\ & S'_{22} & S'_{23} \\ & & S'_{33} \end{bmatrix} \begin{bmatrix} \sigma_x \\ \sigma_y \\ \tau_{xy} \end{bmatrix}$$

$$S'_{11} = S_{11}c^4 + S_{22}s^4 + (S_{33} + 2S_{12})c^2s^2$$

$$S'_{22} = S_{11}s^4 + S_{22}c^4 + (S_{33} + 2S_{12})c^2s^2$$

$$S'_{33} = (2S_{11} + 2S_{22} - S_{33} - 4S_{12})c^2s^2 + S_{33}(c^4 + s^4)$$

$$S'_{12} = (S_{11} + S_{22} - S_{33})c^2s^2 + S_{12}(c^4 + s^4)$$

$$S'_{13} = (2S_{11} - S_{33} - 2S_{12})c^3s - (2S_{22} - S_{33} - 2S_{12})cs^3$$

$$S'_{23} = (2S_{11} - S_{33} - 2S_{12})cs^3 - (2S_{22} - S_{33} - 2S_{12})c^3s.$$

$$\eta_{xy,x} = G_{xy} \left[ \left( \frac{2}{E_1} - \frac{1}{G_{12}} + \frac{2\nu_{21}}{E_2} \right) c^3s - \left( \frac{2}{E_2} - \frac{1}{G_{12}} + \frac{2\nu_{21}}{E_2} \right) cs^3 \right]$$

$$\eta_{xy,y} = G_{xy} \left[ \left( \frac{2}{E_1} - \frac{1}{G_{12}} + \frac{2\nu_{21}}{E_2} \right) cs^3 - \left( \frac{2}{E_2} - \frac{1}{G_{12}} - \frac{2\nu_{21}}{E_2} \right) c^3s \right]$$

$$\nu_{yx} = E_y \left[ \frac{\nu_{21}}{E_2} (c^4 + s^4) \right]$$

$$- \left( \frac{1}{E_1} + \frac{1}{E_2} - \frac{1}{G_{12}} \right) c^2s^2$$

- In the material principal directions we have,

$$\begin{bmatrix} \varepsilon_1 \\ \varepsilon_2 \\ \gamma_{12} \end{bmatrix} = \begin{bmatrix} \frac{1}{E_1} & -\frac{\nu_{21}}{E_2} & 0 \\ -\frac{\nu_{12}}{E_1} & \frac{1}{E_2} & 0 \\ 0 & 0 & \frac{1}{G_{12}} \end{bmatrix} \begin{bmatrix} \sigma_1 \\ \sigma_2 \\ \tau_{12} \end{bmatrix}$$

Engineering Constants:  $E_1, E_2, G_{12}, \nu_{12}$

- It is customary to express the laminate constitutive relationship as

$$\begin{bmatrix} \varepsilon_x \\ \varepsilon_y \\ \gamma_{xy} \end{bmatrix} = \begin{bmatrix} \frac{1}{E_x} & -\frac{\nu_{yx}}{E_y} & \frac{\eta_{xy,x}}{G_{xy}} \\ -\frac{\nu_{xy}}{E_x} & \frac{1}{E_y} & \frac{\eta_{xy,y}}{G_{xy}} \\ \frac{\eta_{x,xy}}{E_x} & \frac{\eta_{y,xy}}{E_y} & \frac{1}{G_{xy}} \end{bmatrix} \begin{bmatrix} \sigma_x \\ \sigma_y \\ \tau_{xy} \end{bmatrix}$$



# 5.1. Generally Orthotropic Laminates

## Analysis of Planar Laminates

- Compliance is off

$$\underline{\underline{\epsilon}}(x, y) = \underline{\underline{T}} \underline{\underline{\epsilon}} \underline{\underline{T}}^{-1} \underline{\underline{\sigma}}(x, y)$$

$$\begin{bmatrix} \epsilon_x \\ \epsilon_y \\ \gamma_{xy} \end{bmatrix} = \begin{bmatrix} S'_{11} & S'_{12} \\ S'_{12} & S'_{22} \\ S'_{13} & S'_{23} \end{bmatrix} \begin{bmatrix} \sigma_x \\ \sigma_y \\ \tau_{xy} \end{bmatrix}$$

$$S'_{11} = S_{11} c^4 + S_{22} s^4$$

$$S'_{22} = S_{11} s^4 + S_{22} c^4$$

$$S'_{33} = (2S_{11} + 2S_{22} - S_{33}) s^2 c^2$$

$$S'_{12} = (S_{11} + S_{22} - S_{33}) s^2 c^2$$

$$S'_{13} = (2S_{11} - S_{33} - S_{66}) s^3 c$$

$$S'_{23} = (2S_{11} - S_{33} - S_{66}) s c^3$$

- In the material plane, we have,

$$\begin{bmatrix} \epsilon_1 \\ \epsilon_2 \\ \gamma_{12} \end{bmatrix} = \begin{bmatrix} \frac{1}{E_1} \sigma_1 \\ -\frac{\nu_{12}}{E_1} \sigma_1 + \frac{1}{E_2} \sigma_2 \\ 0 \end{bmatrix}$$

Engineering Constants:  $E_1, E_2, G_{12}, \nu_{12}$

### Off-Axis Moduli

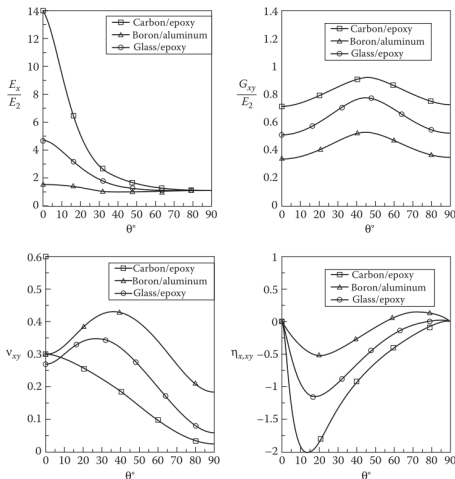

(Figure 2.14 from Gibson 2012)

can write,

can be written as

$$\begin{bmatrix} \sigma_x \\ \sigma_y \\ \tau_{xy} \end{bmatrix} = \begin{bmatrix} \frac{1}{E_1} + \frac{2\nu_{21}}{E_2} c^3 s \\ \frac{2\nu_{21}}{E_2} c^2 s^2 \\ \frac{1}{G_{12}} + \frac{2\nu_{21}}{E_2} c s^3 \\ \frac{1}{G_{12}} + \frac{2\nu_{21}}{E_2} c s^3 \\ \frac{2\nu_{21}}{E_2} c^2 s^2 \\ \frac{1}{G_{12}} + \frac{2\nu_{21}}{E_2} c^3 s \end{bmatrix} \begin{bmatrix} \sigma_x \\ \sigma_y \\ \tau_{xy} \end{bmatrix}$$

express the constitutive relationship as

$$\begin{bmatrix} \sigma_x \\ \sigma_y \\ \tau_{xy} \end{bmatrix} = \begin{bmatrix} \frac{\nu_{yx} x}{E_y} & \frac{\eta_{xy,y,x}}{G_{xy}} \\ \frac{1}{E_y} & \frac{\eta_{xy,y,y}}{G_{xy}} \\ \frac{\eta_{y,xy}}{E_y} & \frac{1}{G_{xy}} \end{bmatrix} \begin{bmatrix} \sigma_x \\ \sigma_y \\ \tau_{xy} \end{bmatrix}$$

## 5.2. Numerical Examples: 1

Analysis of Planar Laminates (Example 2.2 from Gibson 2012)

Consider an orthotropic laminate with the properties

$$E_1 = 140 \text{ GPa}, E_2 = 10 \text{ GPa}, G_{12} = 7 \text{ GPa}, \nu_{12} = 0.3, \nu_{23} = 0.2.$$

Compute the strains if it is subjected to the following state of stress in the principal coordinates:

$$\sigma_1 = 70 \text{ MPa}, \sigma_2 = 140 \text{ MPa}, \tau_{12} = 35 \text{ MPa}, \sigma_3 = \tau_{13} = \tau_{23} = 0.$$

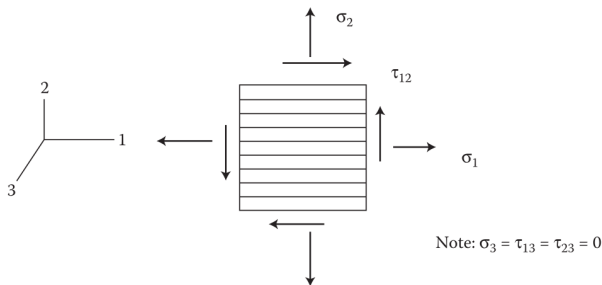

(Figure 2.10 from Gibson 2012)

## 5.2. Numerical Examples: 2

Analysis of Planar Laminates(Example 2.3 from Gibson 2012)

A  $45^\circ$  off-axis tensile test is conducted on a generally orthotropic test specimen by applying a normal stress  $\sigma_x$ . The specimen has strain gauges attached to measure axial and transverse strains ( $\epsilon_x, \epsilon_y$ ). How many engineering parameters can be estimated from measurements of  $\sigma_x, \epsilon_x, \epsilon_y$  ?

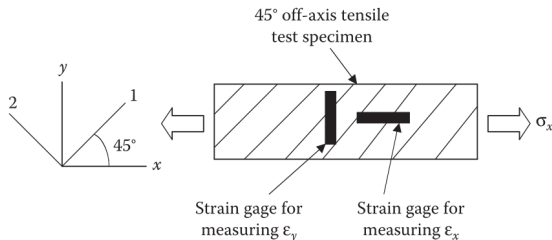

(Figure 2.15 from Gibson 2012)

## 6. Classical Laminate Theory

- In the Kirchhoff-Love Plate Theory we had,

$$\begin{bmatrix} \underline{N} \\ \underline{M} \end{bmatrix} = \begin{bmatrix} \underline{A} & \underline{B} \\ \underline{B} & \underline{D} \end{bmatrix} \begin{bmatrix} \underline{u}' \\ \underline{w}'' \end{bmatrix}$$

where

$$\underline{A} = \frac{Et}{1-\nu^2} \begin{bmatrix} 1 & \nu & 0 \\ \nu & 1 & 0 \\ 0 & 0 & \frac{1-\nu}{2} \end{bmatrix}, \quad \underline{D} = \frac{Et^3}{12(1-\nu^2)} \begin{bmatrix} 1 & \nu & 0 \\ \nu & 1 & 0 \\ 0 & 0 & \frac{1-\nu}{2} \end{bmatrix}, \quad \underline{B} = \underline{0}.$$

- This can also be written in terms of thickness moments of the constitutive

matrix  $\underline{C} = \frac{E}{1-\nu^2} \begin{bmatrix} 1 & \nu & 0 \\ \nu & 1 & 0 \\ 0 & 0 & \frac{1-\nu}{2} \end{bmatrix}$  as

$$\underline{A} = \int_{-\frac{t}{2}}^{\frac{t}{2}} \underline{C} dz, \quad \underline{B} = \int_{-\frac{t}{2}}^{\frac{t}{2}} z \underline{C} dz, \quad \underline{D} = \int_{-\frac{t}{2}}^{\frac{t}{2}} z^2 \underline{C} dz.$$

## 6. Classical Laminate Theory

- Suppose we had different laminate plies along the thickness, such that the constitutive matrix is  $\underline{\underline{C}}_i$  for  $z \in (z_i, z_{i+1})$  and  $-\frac{t}{2} = z_1 < \dots < z_N = \frac{t}{2}$ .
- Then the  $A - B - D$  matrices are written as the sums,

$$\underline{\underline{A}} = \sum_i (z_{i+1} - z_i) \underline{\underline{C}}_i, \quad \underline{\underline{B}} = \sum_i \frac{z_{i+1}^2 - z_i^2}{2} \underline{\underline{C}}_i, \quad \underline{\underline{D}} = \sum_i \frac{z_{i+1}^3 - z_i^3}{3} \underline{\underline{C}}_i.$$

- Unlike isotropic plates, composite laminates can have non-zero  $\underline{\underline{B}}$  matrix (moment-planar coupling), bending-twisting coupling, etc.
- This  $\begin{bmatrix} \underline{\underline{A}} & \underline{\underline{B}} \\ \underline{\underline{B}} & \underline{\underline{D}} \end{bmatrix}$  matrix is known as the **Laminate Stiffness Matrix**.

# 6.1. The Laminate Orientation Code

## Classical Laminate Theory

- Ply angles separated by slashes, ordered from top to bottom
- Subscript “s” for symmetric laminates
- Numerical subscripts for repetitions
- Center ply with an overbar for odd laminates

(See sec. 7.1 in Gibson 2012)

### Types

- Symmetric, Antisymmetric, Asymmetric
- Angle-Ply, Cross-Ply, Balanced,  $\pi/4$  laminates

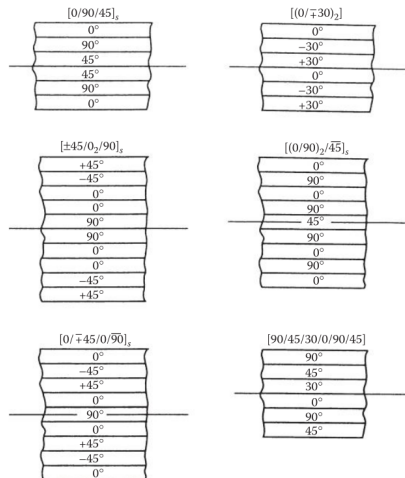

(Figure 7.1 from Gibson 2012)

# 6.1. The Laminate Orientation Code

## Classical Laminate Theory

- Ply angles separated by slashes and ordered from top to bottom
- Subscript “s” for symmetric laminates
- Numerical subscript for number of repetitions
- Center ply with 0° for odd number of repetitions

(See slide 10)

### Types

- Symmetric, Antisymmetric
- Angle-Ply, Cross-ply
- Quasi-isotropic laminates

## Summary of Laminate Stiffnesses

**Table 3.4.** The  $[A]$ ,  $[B]$ ,  $[D]$  matrices for laminates. When the laminate is symmetrical, the  $[B]$  matrix is zero. Cross-ply laminates are orthotropic.

$[A]$	$[B]$	$[D]$
<b>Symmetrical</b>		
$\begin{bmatrix} A_{11} & A_{12} & A_{16} \\ A_{12} & A_{22} & A_{26} \\ A_{16} & A_{26} & A_{66} \end{bmatrix}$	$\begin{bmatrix} 0 & 0 & 0 \\ 0 & 0 & 0 \\ 0 & 0 & 0 \end{bmatrix}$	$\begin{bmatrix} D_{11} & D_{12} & D_{16} \\ D_{12} & D_{22} & D_{26} \\ D_{16} & D_{26} & D_{66} \end{bmatrix}$
<b>Balanced</b>		
$\begin{bmatrix} A_{11} & A_{12} & 0 \\ A_{12} & A_{22} & 0 \\ 0 & 0 & A_{66} \end{bmatrix}$	$\begin{bmatrix} B_{11} & B_{12} & B_{16} \\ B_{12} & B_{22} & B_{26} \\ B_{16} & B_{26} & B_{66} \end{bmatrix}$	$\begin{bmatrix} D_{11} & D_{12} & D_{16} \\ D_{12} & D_{22} & D_{26} \\ D_{16} & D_{26} & D_{66} \end{bmatrix}$
<b>Orthotropic</b>		
$\begin{bmatrix} A_{11} & A_{12} & 0 \\ A_{12} & A_{22} & 0 \\ 0 & 0 & A_{66} \end{bmatrix}$	$\begin{bmatrix} B_{11} & B_{12} & 0 \\ B_{12} & B_{22} & 0 \\ 0 & 0 & B_{66} \end{bmatrix}$	$\begin{bmatrix} D_{11} & D_{12} & 0 \\ D_{12} & D_{22} & 0 \\ 0 & 0 & D_{66} \end{bmatrix}$
<b>Isotropic</b>		
$\begin{bmatrix} A_{11} & A_{12} & 0 \\ A_{12} & A_{11} & 0 \\ 0 & 0 & \frac{A_{11}-A_{12}}{2} \end{bmatrix}$	$\begin{bmatrix} B_{11} & B_{12} & 0 \\ B_{12} & B_{11} & 0 \\ 0 & 0 & \frac{B_{11}-B_{12}}{2} \end{bmatrix}$	$\begin{bmatrix} D_{11} & D_{12} & 0 \\ D_{12} & D_{11} & 0 \\ 0 & 0 & \frac{D_{11}-D_{12}}{2} \end{bmatrix}$
<b>Quasi-isotropic</b>		
$\begin{bmatrix} A_{11} & A_{12} & 0 \\ A_{12} & A_{11} & 0 \\ 0 & 0 & \frac{A_{11}-A_{12}}{2} \end{bmatrix}$	$\begin{bmatrix} B_{11} & B_{12} & B_{16} \\ B_{12} & B_{22} & B_{26} \\ B_{16} & B_{26} & B_{66} \end{bmatrix}$	$\begin{bmatrix} D_{11} & D_{12} & D_{16} \\ D_{12} & D_{22} & D_{26} \\ D_{16} & D_{26} & D_{66} \end{bmatrix}$

(Table 3.4 from Kollár and Springer 2003)

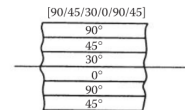
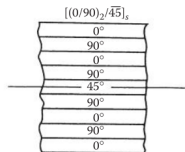
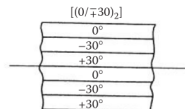

Gibson 2012

## 6.2. Laminated Beams

### Classical Laminate Theory

- Consider a beam with a symmetric section on the  $x - y$  plane. Invoking Kirchhoff kinematic assumptions we have:  $\varepsilon_x = u' - yv''$ .
- The stress distribution will depend on the section-coordinate. In general we will have:  $\sigma_x = E_x(y)\varepsilon_x = E_x(y)(u' - yv'')$ .
- We get the effective normal reaction  $N_x$  by integrating the stress over the section:

$$N_x = \int_{\mathcal{A}} \sigma_x = \left[ \int_{\mathcal{A}} E_x(y) \right] u' + \left[ \int_{\mathcal{A}} -yE_x(y) \right] v''.$$

- Similarly we get the bending moment  $M_z$  as the first moment of the stress,

$$M_z = \int_{\mathcal{A}} -y\sigma_x = \left[ \int_{\mathcal{A}} -yE_x(y) \right] u' + \left[ \int_{\mathcal{A}} y^2E_x(y) \right] v''.$$

- In summary we have the beam-analog of the laminate stiffness matrix,

**Important note:** We have assumed that no torsion/twist is present. See Kollár and Springer 2003 for the general form.

$$\begin{bmatrix} N_x \\ M_z \end{bmatrix} = \begin{bmatrix} A & B \\ B & D \end{bmatrix} \begin{bmatrix} u' \\ v'' \end{bmatrix}.$$



## 6.2. Laminated Beams

### Classical Laminate Theory

- For a laminated composite with a rectangular section with width  $b$ , the integrals may be simplified as,

$$A = \int_{\mathcal{A}} E_x(y) = \sum_{i=1}^N E_{x,i} b (y_{i+1} - y_i), \quad B = \int_{\mathcal{A}} -y E_x(y) = - \sum_{i=1}^N E_{x,i} b \frac{y_{i+1}^2 - y_i^2}{2}$$

$$D = \int_{\mathcal{A}} y^2 E_x(y) = \sum_{i=1}^N E_{x,i} b \frac{y_{i+1}^3 - y_i^3}{3}.$$

- For plies of uniform thickness we can write

$$y_i = -\frac{h}{2} + (i-1) \frac{h}{N},$$

which leads to:

$$A = \frac{h}{N} \sum_{i=1}^N E_{x,i}, \quad B = \frac{h^2}{2N^2} \sum_{i=1}^N E_{x,i} (2i - N - 1),$$

$$D = \frac{h^3}{12N^3} \sum_{i=1}^N E_{x,i} (12i^2 - 12Ni + 12N^2 + 3N^2 + 6N + 4)$$

## 6.3. Numerical Example

### Classical Laminate Theory

Determine the ABD matrix for the following composite beams where the ply thickness is 1 mm and beam width is 10 mm:

- $[0/90]_s$ , and
- $[0/90/0/90]$ .

Assume the following properties for each lamina:  $E_1 = 140$  GPa,  $E_2 = 10$  GPa,  $G_{12} = 7$  GPa,  $\nu_{12} = 0.3$ ,  $\nu_{23} = 0.2$ .

# References I

- [1] Ronald F. Gibson. **Principles of Composite Material Mechanics**, 3rd ed. Dekker Mechanical Engineering. Boca Raton, Fla: Taylor & Francis, 2012. ISBN: 978-1-4398-5005-3 (cit. on pp. **2**, **18–23**, **36–42**, **52–59**, **62**, **63**).
- [2] László P. Kollár and George S. Springer. **Mechanics of Composite Structures**, Cambridge: Cambridge University Press, 2003. ISBN: 978-0-521-80165-2. DOI: [10.1017/CB09780511547140](https://doi.org/10.1017/CB09780511547140). (Visited on 01/11/2025) (cit. on pp. **2**, **17**, **21**, **22**, **26**, **62–64**).
- [3] T. H. G. Megson. **Aircraft Structures for Engineering Students**, Elsevier, 2013. ISBN: 978-0-08-096905-3 (cit. on pp. **2**, **9–13**).
- [4] Isaac M. Daniel and Ori Ishai. **Engineering Mechanics of Composite Materials**, 2nd ed. New York: Oxford University Press, 2006. ISBN: 978-0-19-515097-1 (cit. on pp. **2**, **24**, **25**).
- [5] *NPTEL Online-IIT KANPUR*. [https://archive.nptel.ac.in/content/storage2/courses/101104010/ui/Course\\_home-1.html](https://archive.nptel.ac.in/content/storage2/courses/101104010/ui/Course_home-1.html). (Visited on 01/22/2025) (cit. on pp. **3–6**).
- [6] *Carbon Fiber Top Helicopter Blades*. (Visited on 01/22/2025) (cit. on pp. **3–6**).
- [7] Şevket Kalkan. “TECHNICAL INVESTGATION FOR THE USE OF TEXTILE WASTE FIBER TYPES IN NEW GENERATION COMPOSITE PLASTERS”. PhD thesis. July 2017 (cit. on pp. **3–6**).
- [8] “Micro-Mechanics of Failure”. **Wikipedia**, (May 2024). (Visited on 01/22/2025) (cit. on pp. **7**, **8**).
- [9] Simon Skovsgaard and Simon Heide-Jørgensen. “Three-Dimensional Mechanical Behavior of Composite with Fibre-Matrix Delamination through Homogenization of Micro-Structure”. **Composite Structures**, **275**, (July 2021), pp. 114418. DOI: [10.1016/j.compstruct.2021.114418](https://doi.org/10.1016/j.compstruct.2021.114418) (cit. on pp. **7**, **8**).